

## PE6324L

30A/32A 24-Outlet Metered & Switched Low Profile eco PDU

PE6324LB



- 0U 24-Outlet low profile eco PDU
- Bank level metering
- Supports Proactive Overload Protection (POP) / Outlet Switch Control

The PE6324L PDUs are low-profile units featuring 24 AC outlets, coming available in various IEC or NEMA socket configurations. This series has a smaller input region on the PDU to provide more installation space for data centers.

The PE6324L eco PDUs offers remote power control with real-time power measurement - allowing users to monitor the power status of devices attached to the PDUs, either at the PDU device or Bank level, from practically any location via a TCP / IP connection. The power status of each outlet can be set individually, allowing users to switch each device On / Off.

This series supports any 3rd party v1, v2 & v3 SNMP Manager Software and ATEN [eco DC](#) (Energy & DCIM Management Web GUI), delivering an easy method for multiple device management while offering an intuitive and user-friendly GUI that allows users to configure a PDU device and monitor power status of the equipment connected to it.

### Features

- **Connections**
  - Support 10/100Mbit Ethernet Interface
  - Support TCP/IP, UDP, HTTP, HTTPS, SSL, DHCP, SMTP, NTP, DNS, Auto Sense, Ping, Telnet, and SNMP V1,V2&V3
  - Support 2-level account/password security, IP/MAC filter, 128 bit SSL, RADIUS
  - Support : [eco DC](#), Browser (IE, Firefox, Chrome, Safari)
- **Metering**
  - Bank level power metering and monitoring
  - Environment Monitoring : support external temperature/temperature & humidity sensors for rack temperature and humidity monitoring
  - Current, voltage, power, power dissipation, temperature, and humidity metering and threshold level setting
- **Outlet Switch Control**
  - Remote power outlet control ( On/Off, Power Cycle) by individual outlets and outlet groups
  - Support multiple power control methods – Wake on LAN, System After AC Back, Kill the Power
  - Power-On sequencing – users can set the power on sequence and delay time for each outlet to allow equipment to be turned on in the proper order
  - Proactive Overload Protection (POP) – automatically powers off outlets when current overloads to protect operating devices

**Specifications**

Function	PE6324LB	PE6324LG
<b>Electrical</b>		
Nominal Input Voltage	100 – 240 VAC	100 – 240 VAC
Maximum Input Current	30A (Max); 24A (UL-derated)	30A(Max)
Input Frequency	50-60 Hz	50-60 Hz
Input Connection	NEMA L6-30P	IEC 60309 32A
Input Power	6240 VA(Max) ; 4992 VA(UL de-rated)	7360 VA(Max)
Outlet Type	Total: 21 x IEC320 C13 + 3 x IEC320 C19 Bank1-1: Outlet 1 – 8; 7 x C13 + 1 x C19 Bank1-2: Outlet 9 – 16; 7 x C13 + 1 x C19 Bank2: Outlet 17 – 24; 7 x C13 + 1 x C19	Total: 21 x IEC320 C13 + 3 x IEC320 C19 Bank1-1: Outlet 1 – 8; 7 x C13 + 1 x C19 Bank1-2: Outlet 9 – 16; 7 x C13 + 1 x C19 Bank2: Outlet 17 – 24; 7 x C13 + 1 x C19
Nominal Output Voltage	100 – 240 VAC	100 – 240 VAC
Maximum Output Current (Outlet)	C13: 15A (Max) ; 12A (UL de-rated) C19: 20A (Max) ; 16A (UL de-rated)	C13: 10A(Max) C19: 16A(Max)
Maximum Output Current (Bank)	15A (Max) ; 12A (UL de-rated)	16A(Max)
Maximum Output Current (Total)	30A (Max) ; 24A (UL de-rated)	30A(Max)
Breakers	2 x 16A Slim Breaker	2 x 16A Slim Breaker
Metering	Bank Level Current, Voltage, VA , PF and kWh Monitoring	Bank Level Current, Voltage, VA , PF and kWh Monitoring
Outlet Switching	Yes	Yes
Environment Sensor Ports	2	2
Metering Accuracy	Voltage Range: 100VAC ~ 250VAC +/-1% Power Range: 100W ~ Maximum Capacity +/- 2% Current Range: 0.1A~1A +/- 0.1A, 1A~20A +/-1%	Voltage Range: 100VAC ~ 250VAC +/-1% Power Range: 100W ~ Maximum Capacity +/- 2% Current Range: 0.1A~1A +/- 0.1A, 1A~20A +/-1%
<b>Physical Properties</b>		
Dimensions (L x W x H)	177.50 x 6.60 x 4.40 cm (69.88 x 2.6 x 1.73 in.)	177.50 x 6.60 x 4.40 cm (69.88 x 2.6 x 1.73 in.)
Weight	5.76 kg ( 12.69 lb )	5.76 kg ( 12.69 lb )
Power Cord Length	1.6 m	1.6 m
<b>Environmental</b>		
Temperature (Operating / Storage)	0–50°C / -20–60°C	0–40°C / -20–60°C
Humidity (Operating & Storage)	0–80% RH, Non-Condensing	0–80% RH, Non-Condensing
<b>Compliance</b>		
EMC Verification	FCC, Others by Request	CE, C-Tick, Others by Request
Safety Verification	By Request	CE-LVD, Others by Request
Note	For some of rack mount products, please note that the standard physical dimensions of WxDxH are expressed using a LxWxH format.	

Diagram

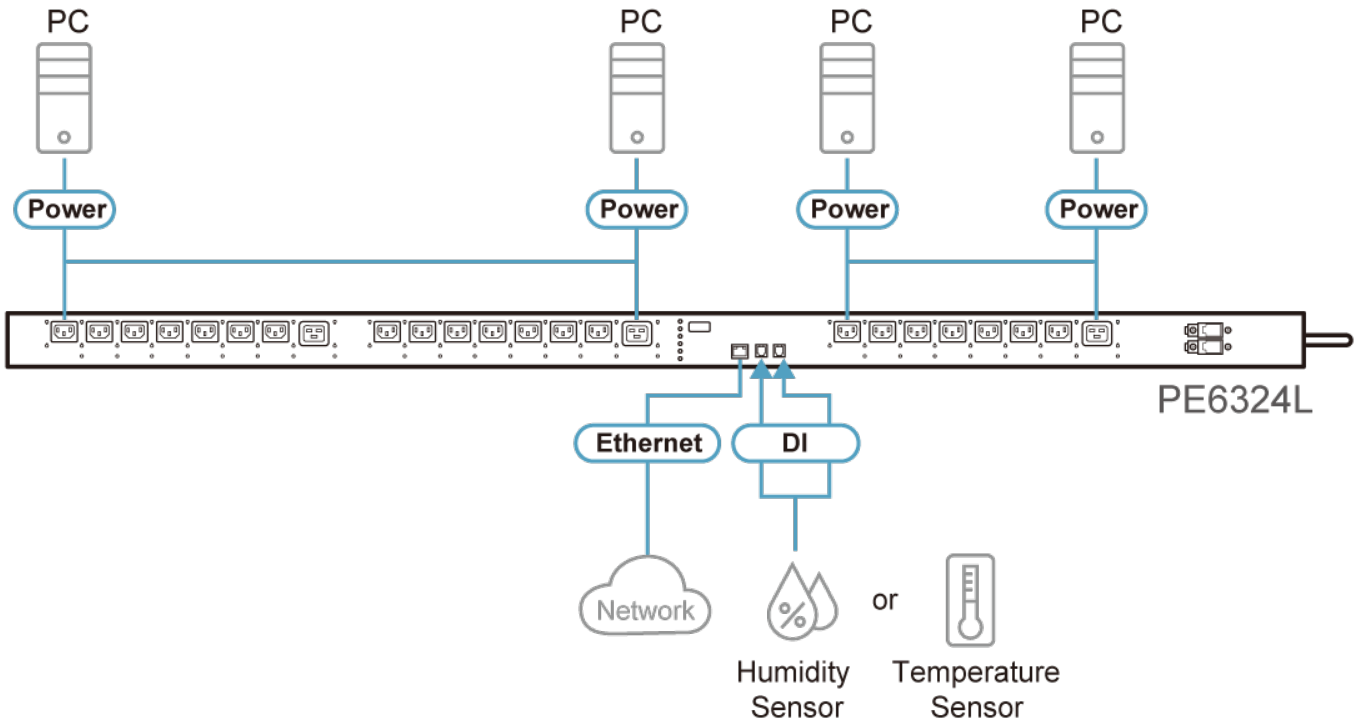

**ATEN International Co., Ltd.**

3F., No.125, Sec. 2, Datong Rd., Sijhih District., New Taipei City 221, Taiwan  
Phone: 886-2-8692-6789 Fax: 886-2-8692-6767  
www.aten.com E-mail: marketing@aten.com



© Copyright 2015 ATEN® International Co., Ltd.  
ATEN and the ATEN logo are trademarks of ATEN International Co., Ltd.  
All rights reserved. All other trademarks are the property of their respective owners.