

### US3384i

8 x 4 USB 3.2 Gen 1 Industrial Sharing Switch



**8x4 USB 3.2 Gen 1 Sharing Switch**  
Smooth BYOD Sharing for Smarter Meetings

US3384i

Driven by the shift to hybrid and remote work, the US3384i is designed to elevate your BYOM/BYOD meeting experience with ease. Meeting room setups are straightforward and effortless, thanks to its plug-and-play design that allows connections to up to 8 PCs/laptops and sharing of up to 4 USB 3.2 Gen 1 devices in no time. With blazing-fast data transmission, cross-platform compatibility (e.g. Windows, macOS, Linux), and flexible port-switching, the USB sharing switch further streamlines meeting workflows, enhances collaboration, and reduces the overhead of IT procurement and management for workplaces.



8x PC Connections



RS-232 / 485



Power-On Detection



USB 3.2 Gen 1



USB Battery Charging 1.2



Mounting Kit

**Plug in – Collaborate – Share in Seconds**

Join the meeting anytime and start to take part in discussion, share data or switch to collaborate – all in just seconds.

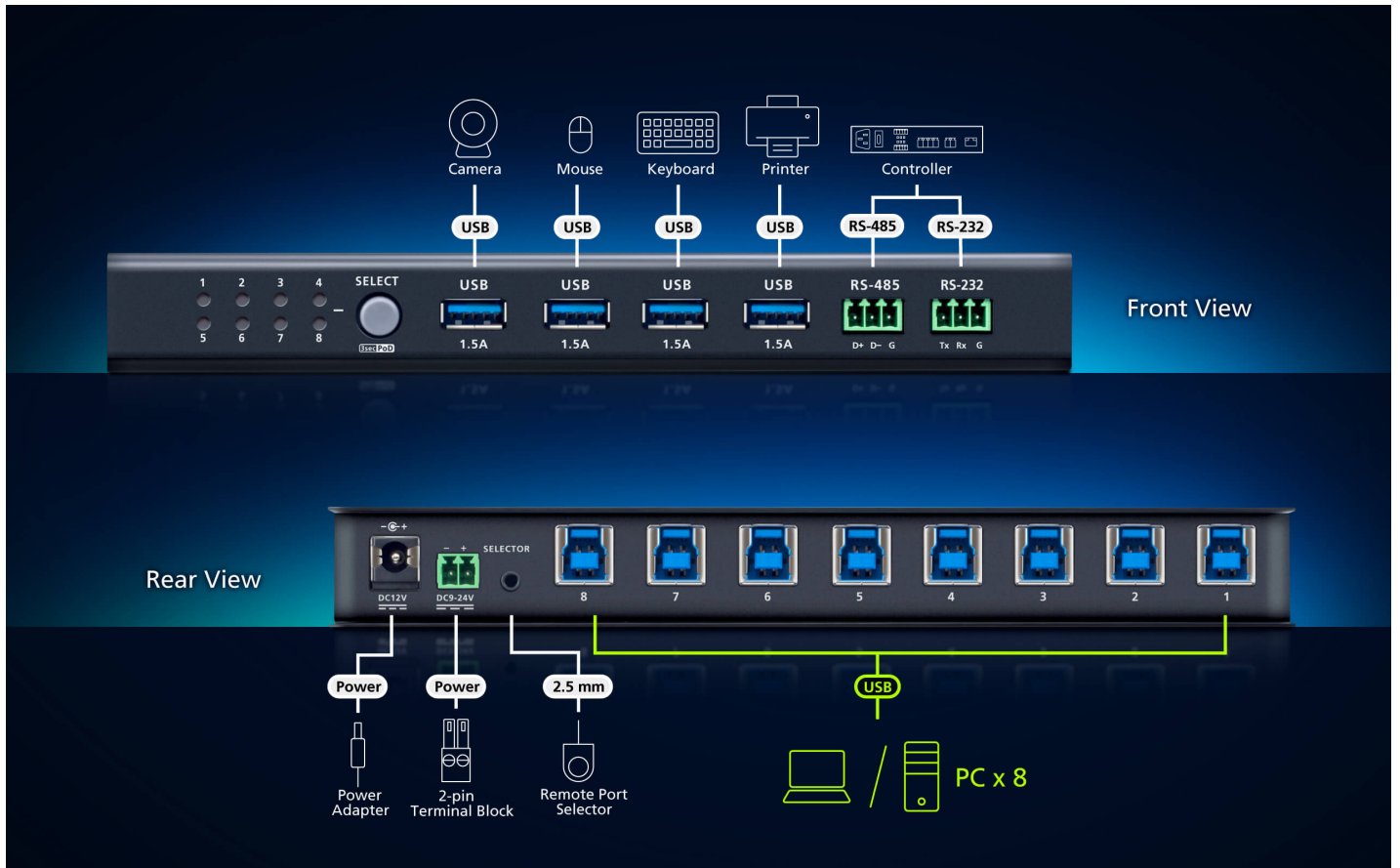

**Seamless Integration into Control System**

The USB sharing switch can be seamlessly integrated into a control system (e.g. ATEN Control System – [VK1100A](#), [VK211](#)) as part of the meeting room setup via its serial connectivity, with the control system serving as a centralized platform to streamline AV/IT management and simplify maintenance.

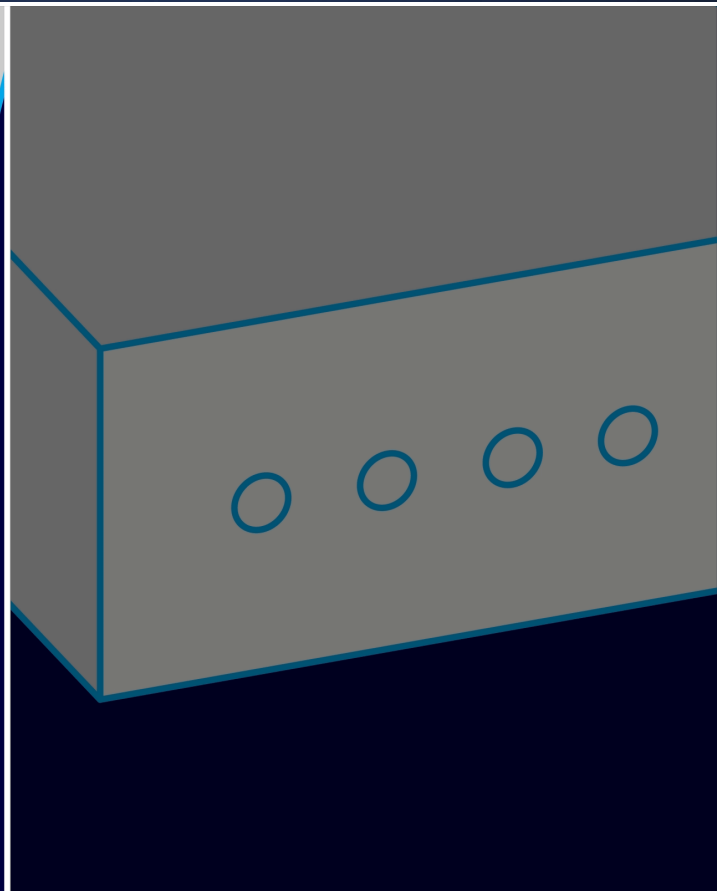
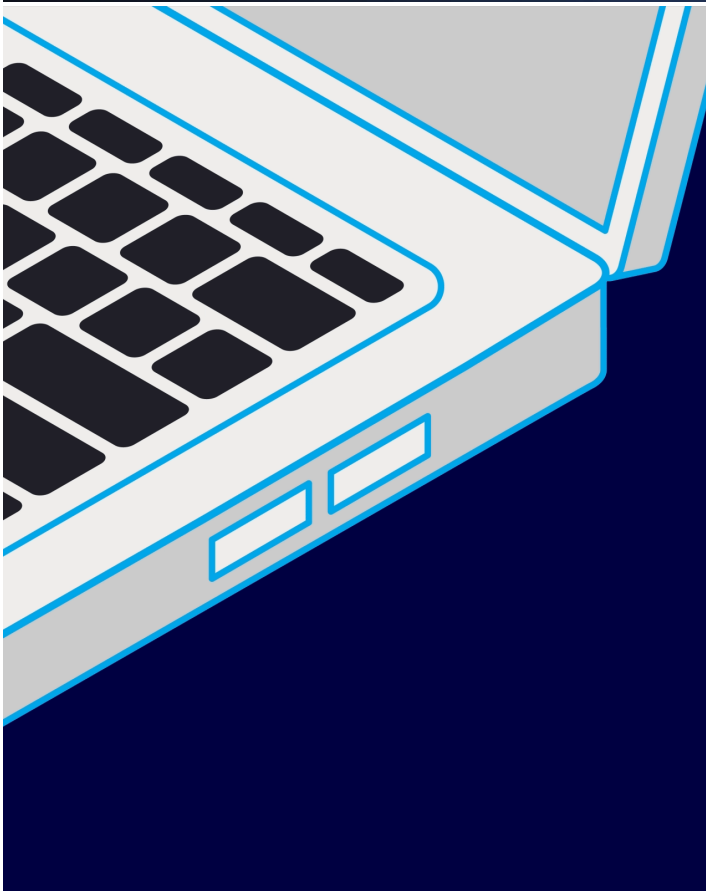

**Power-On Detection to Switch Control**

The USB switch will shift the PC focus to the most recently connected host device, with the corresponding port LED illuminated to indicate which active port has control over the resources.  
Note: Long press the pushbutton to turn on/off the Power-On Detection feature.

**Up to 5 Gbps Data Transfer Rate with USB 3.2 Gen 1**

To maintain an efficient meeting flow, take advantage of the superior 5 Gbps data transfer speed of the built-in USB 3.2 Gen 1 ports, which are also backward compatible with USB 2.0/1.1 devices.



- 1.
- 2.
- 3.
- 4.



Meeting Room (BYOD)

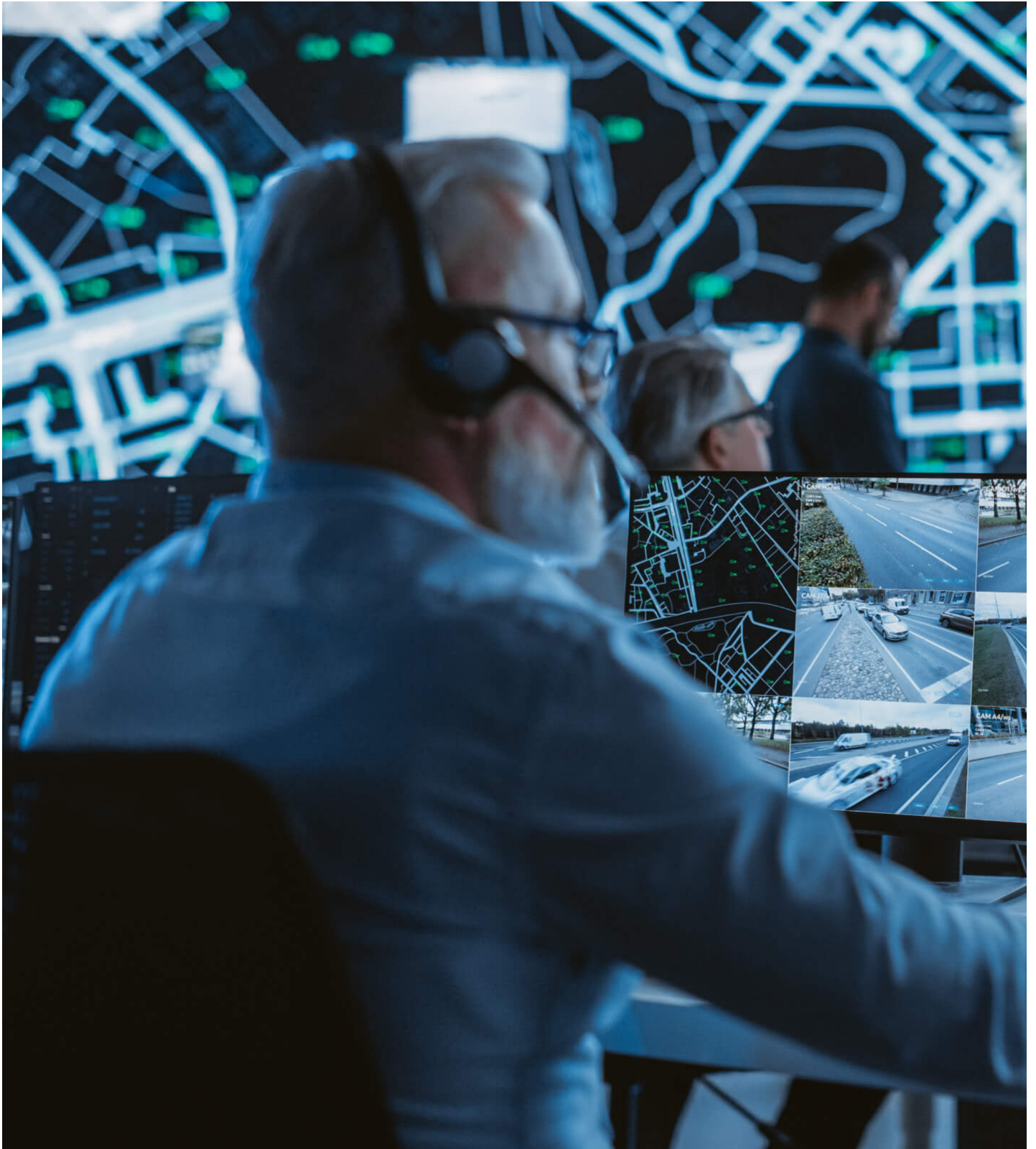

Surveillance



Industrial Control

[Previous](#) [Next](#)

Talk to Our Experts

If you prefer to have ATEN contact you, please complete the form and a representative will be in touch with you shortly

First Name \*

Last Name \*

- Country \*

Company \*

Email \*

Phone Number \*

- Customer Type \*

Job Title \*

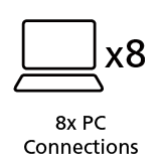
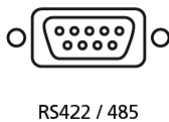
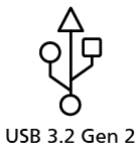

**Features**

Built to take your BYOM/BYOD experience to the next level, the US3384i allows sharing of up to 4 USB 3.2 devices, such as keyboards, mice, cameras, speakerphones, and sound bars, among 8 PCs to declutter workspaces while permitting smooth USB content sharing across multiple meeting participants.

Conferences are kept disruption-free thanks to its blazing fast bandwidth speed of 5 Gbps and the backward compatibility with USB 2.0/1.1 devices, ensuring swift data transmission. In addition, the US3384i boasts versatile port selection methods, including the pushbutton on the front, the RS-232/RS-485 serial commands, and the external remote port selector\*, which add more flexibility to its operation. The US3384i supports Power on Detection function, which automatically switches the PC focus to the last plugged-in/power-on host device. What is more, the priority port preference is configurable, allowing the focus to switch to a secondary USB host when the primary one is lost. The front-panel port status LEDs illuminate to indicate which one of the PCs connected to the US3384i is having the focus at a glance.

In terms of installation, the US3384i comes with plug-and-play support on Windows and macOS operating systems, meaning no drivers are needed. It is also hot-pluggable, so users can connect/disconnect the host devices dynamically to the US3384i without powering off the switch. The case is constructed with premium metal for enhanced durability and supports wall-mounting to meet more installation requirements.

\*The remote port selector is sold separately. Please contact your ATEN dealer for product information.

- Allows sharing of up to 4 USB 3.2 devices among 8 PCs
- Bandwidth speed of 5 Gbps and backward compatibility with USB 2.0/1.1 to ensure swift data transmission
- Versatile port selection methods – front panel pushbutton, RS-232/RS-485 serial commands, and external remote port selector <sup>1</sup>
- Power on Detection
  - Automatically switches the PC focus to the last plugged-in/power-on host device
  - Configurable priority port preference – allows the focus to switch to a secondary USB host when the primary one is lost
- Front panel port status LEDs – indicate which one of the PCs connected to the US3384i is having the focus at a glance
- Supports USB BC 1.2 to ensure sufficient power for downstream USB devices
- Overvoltage protection circuit – extends device lifespan and minimizes risks of electrical hazards/explosions led by voltage spikes surpassing safe operating limits
- Supports DC 9 – 24V power input through terminal block<sup>2</sup>
- Plug-and-play on Windows and macOS operating systems – no drivers are needed
- Hot-pluggable – users can connect/disconnect the host devices dynamically to the US3384i without powering off the switch
- Wall-mountable case constructed with premium metal for enhanced durability

**Note:**

1. The remote port selector is sold separately, please contact your ATEN dealer for product information.
2. Supports either of the following power supplies:
  - (1) DC terminal block
  - (2) DC power jack (The power adapter (0AD8-8012-50M2) is sold separately, please contact your ATEN dealer for product information.)

Diagram

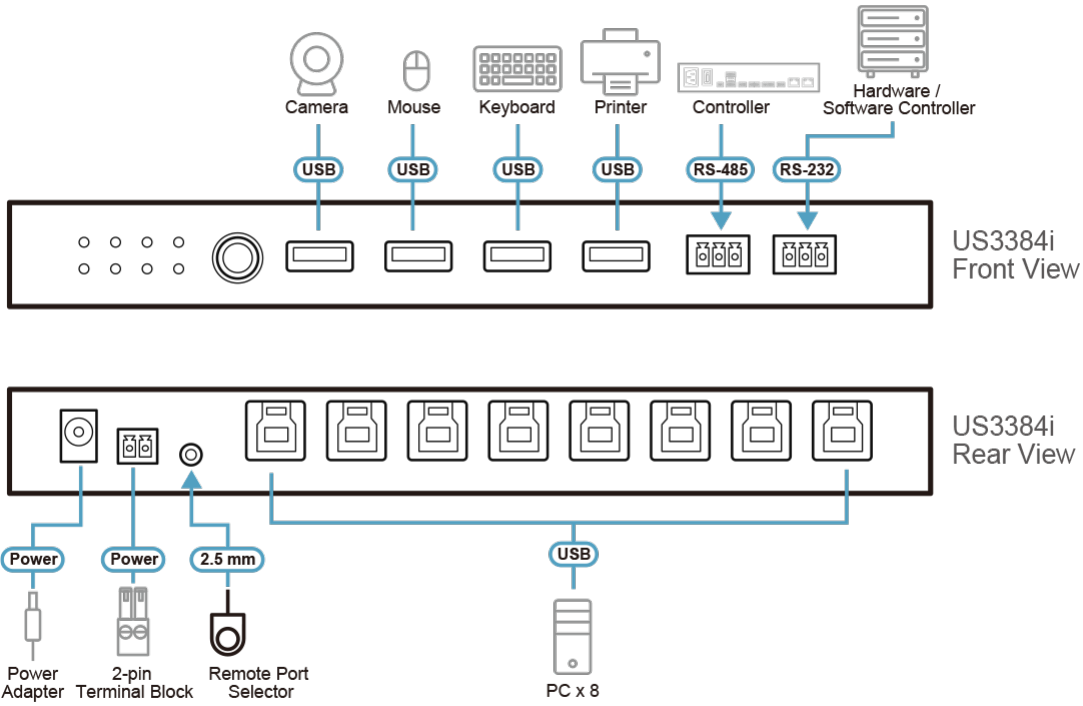

**ATEN International Co., Ltd.**

3F., No.125, Sec. 2, Datong Rd., Sijhih District., New Taipei City 221, Taiwan  
 Phone: 886-2-8692-6789 Fax: 886-2-8692-6767  
 www.aten.com E-mail: marketing@aten.com



© Copyright 2015 ATEN® International Co., Ltd.  
 ATEN and the ATEN logo are trademarks of ATEN International Co., Ltd.  
 All rights reserved. All other trademarks are the property of their  
 respective owners.