

VE8962T

True 4K HDMI over IP Transmitter with PoE



Transform Retail Spaces with Stunning True 4K Digital Signage

Video over IP. Network & Power Redundancy.

4K TRUE **GOOD DESIGN AWARD 2024** **VE8962** True 4K HDMI over IP Transmitter / Receiver with PoE

The VE8962 is a flagship HDMI-over-IP video extender that delivers pristine True 4K resolution with ultra-low latency over both Ethernet and fiber optic connectivity, making it ideal for versatile digital signage requirements. Whether in point-to-point or multipoint-to-multipoint installations, the VE8962 integrates seamlessly into existing networks, delivering uncompromised audiovisual content and control signals via HDMI, audio, USB, RS-232, and IR interfaces.

It is also flexibly scalable through daisy-chain deployment without the need for additional network switches, simplifying AV installations with cost, time, and space efficiency. Designed with sustainable service uptime and streamlined AV management in mind, the VE8962 features both network and power redundancy, along with intuitive web-GUI management – delivering a truly high-performance and cost-effective solution for any professional AV deployment.

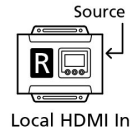

4K TRUE

Network Redundancy to Sustain System Availability

The VE8962 ensures smooth and reliable over-IP AV transmission over long distances via both LAN and optical network connections, maintaining system uptime through connection failover.

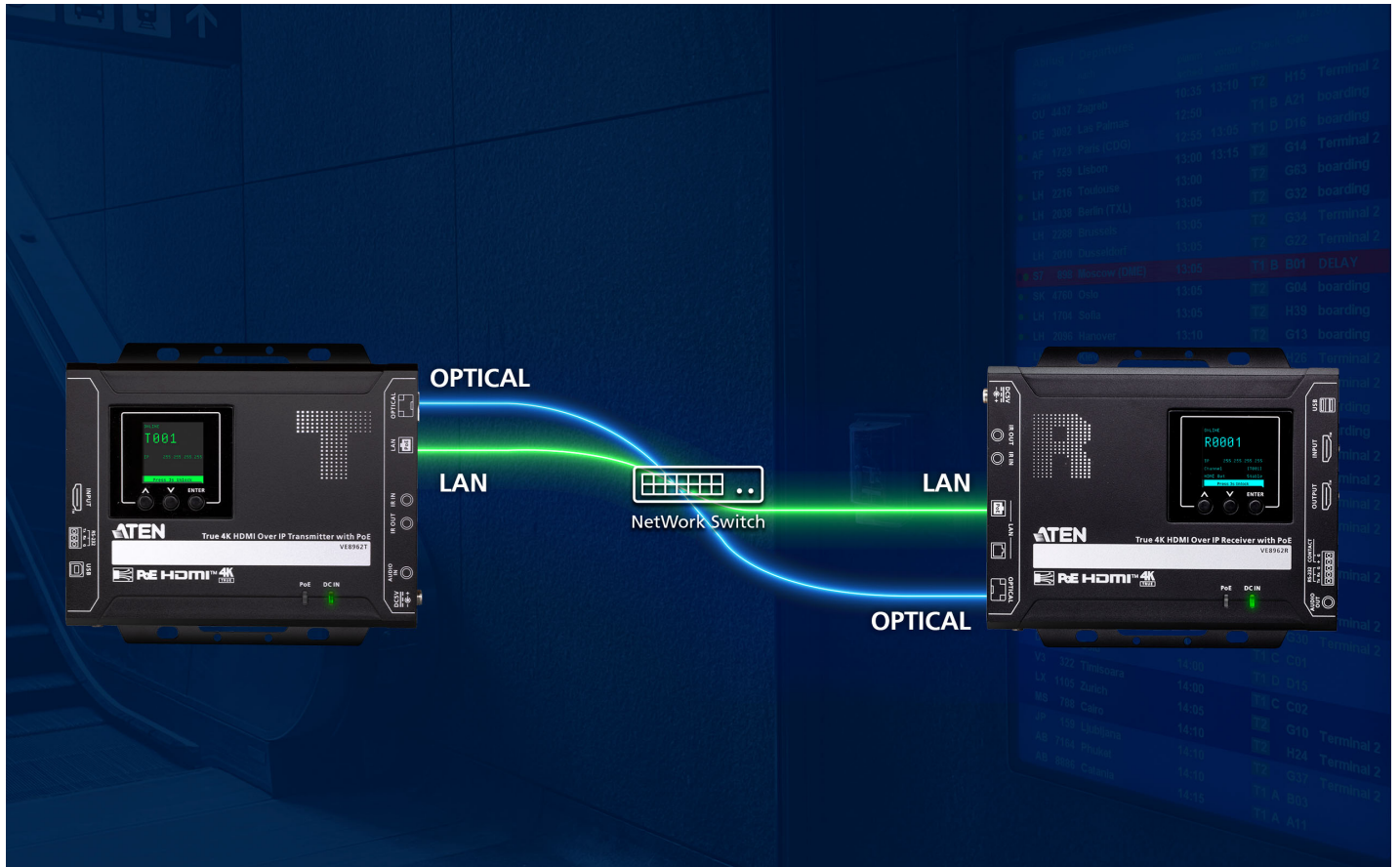

Versatile AV Configuration via Embedding / De-Embedding Audio

By embedding audio directly into the HDMI signal, both audio and video streams can be consolidated into a single HDMI connection, simplifying connectivity. Additionally, the audio can also be de-embedded to separate it from the video stream, ensuring compatibility with various audio systems when necessary.

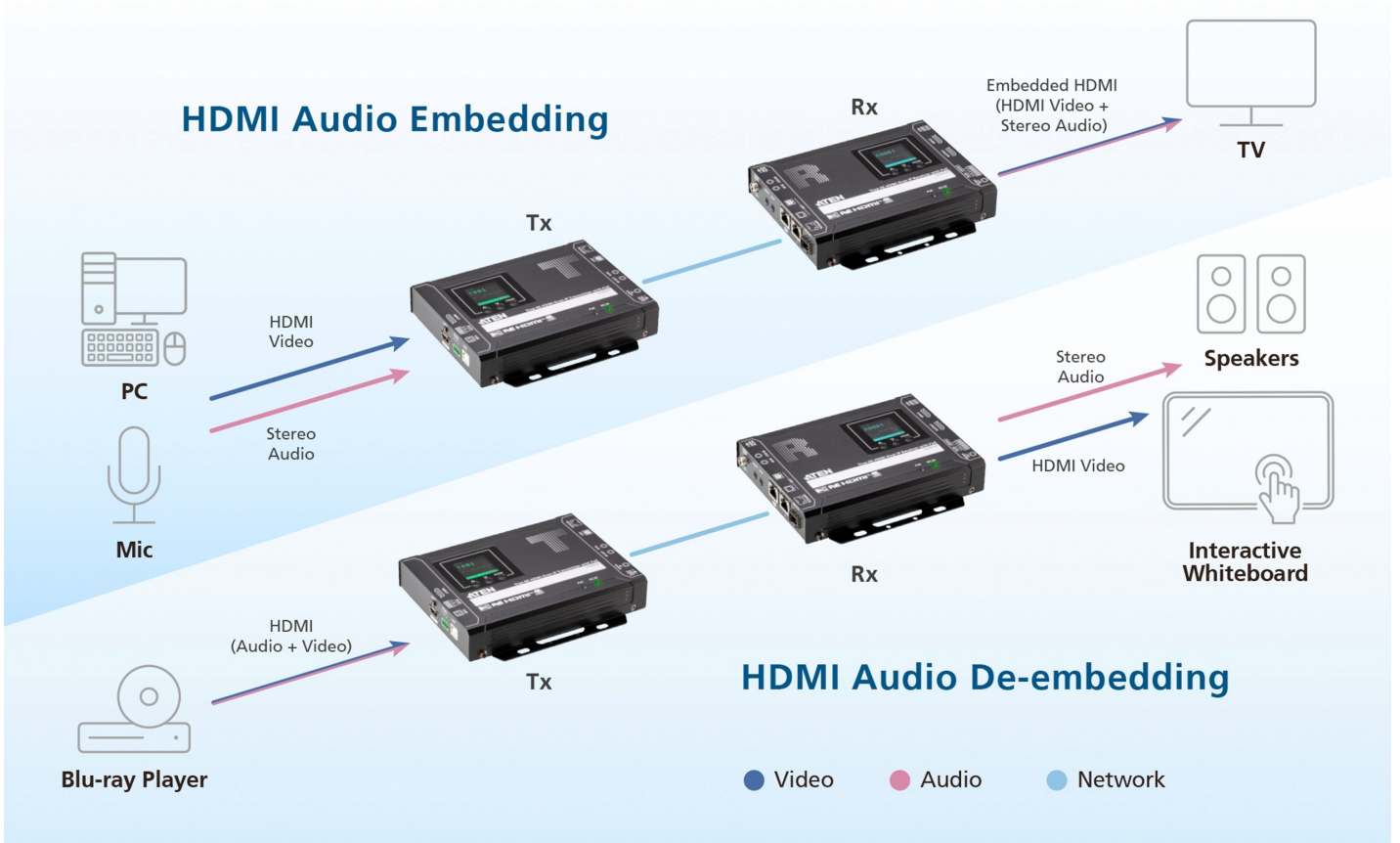

Video Wall Distributions

The VE8962 can integrate easily into any video wall setup for comprehensive, large-scale audiovisual presentations, delivering content across up to 80 displays (e.g., 8x10 array) in either portrait or landscape orientation (90°/270°).

**Local HDMI Input for Real-Time Source Updates**

In situations where a timely update is required on the spot, the VE8962's HDMI input allows plug-and-play connection to a source device for quick content setup at the receiver site. With a remote port selector (part number: 2XRT-0016G) connected to the Contact port, you can easily switch between local and remote content sources as needed.



Streamlined AV Management via Web GUI

What you see is what you get. All audiovisual content is easily managed through the intuitive web GUI, which allows drag-and-drop placement of selected AV sources into customizable display layouts and backgrounds.



Scalable AV over IP Deployment

The VE8962 supports scalable AV over IP deployment with hundreds of endpoints across network infrastructure, enabling both point-to-point and multipoint-to-multipoint installations without distance limitations – offering the flexibility to adapt and expand your AV infrastructure as needed.



Daisy-Chaining Up to 30 Units

The networked AV infrastructure is scalable with up to 30 daisy-chained receiver units streaming video content from a single source, enabling flexible video distribution over the existing network – minimizing the need for additional network switches while maximizing efficiency in cost, time, and space.

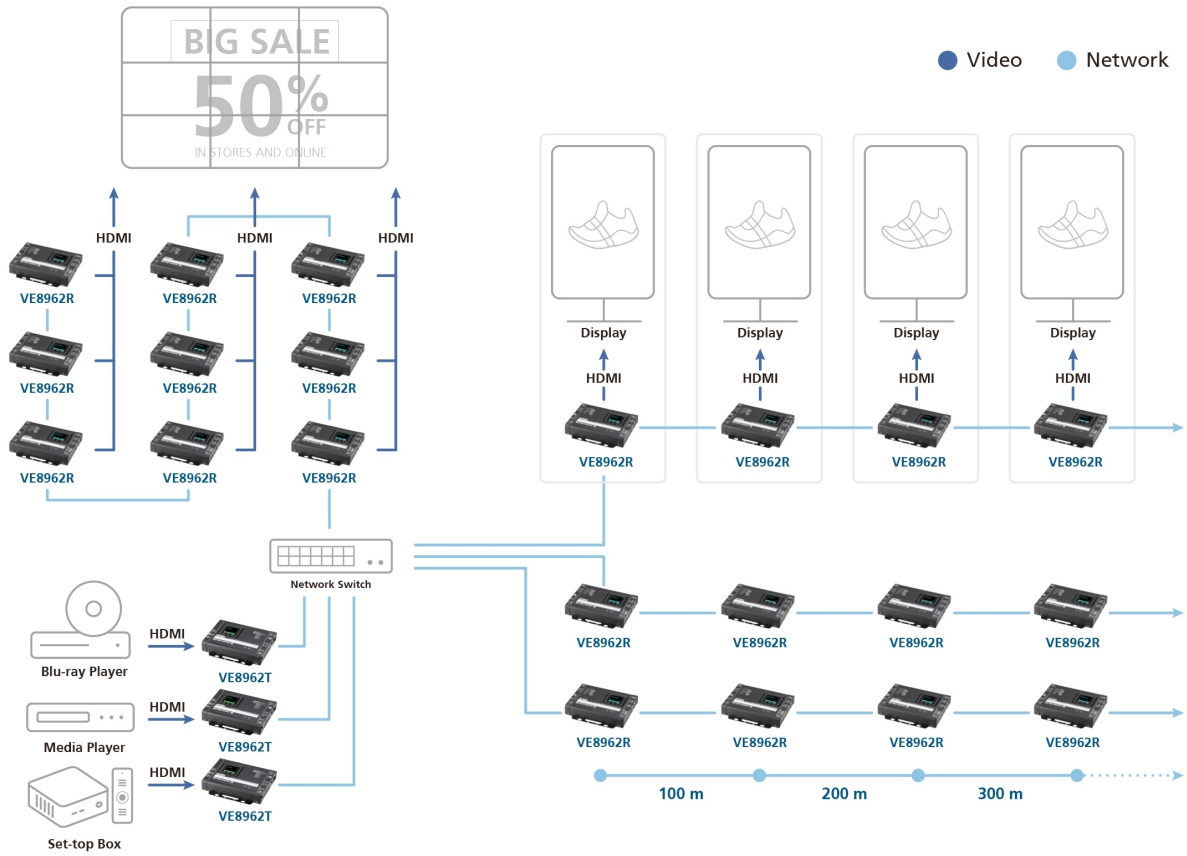

Applications

Designed for scalable networked AV deployments with pristine audiovisual clarity in mind, the VE8962 excels in any digital signage application.



Shopping Malls

Transit Hubs

Exhibitions

Multipurpose Stadiums

Time	Operator	Destination	Terminal	Gate	Boarding
8:00	AirFrance	PARIS	T1	11	8:40
9:15	AirFrance Air	LONDON	T1	21	9:15
9:30	Air Line	LONDON	T1	26	9:30
9:45	ExpAir	NEW YORK	D2	5	9:45
10:45	AeroFlow	NEW YORK	T1	11	10:45
11:00	AeroFlow	SYDNEY	D2	21	11:00
11:30	Omega	VANCOUVER	D2	24	11:30
11:40	Arrow	PARIS	T1	10	11:40
12:00	Arrow	LONDON	T1	13	12:00
12:10	ExpAir	MOSCOW	T1	21	12:10
12:20	AeroFlow	TOKYO	D2	8	12:20
12:30	AeroFlow	SEOUL	T1	15	12:30
12:45	AirFrance Air	LISBADDY	D2	13	12:45
12:45	AirFrance Air	AUSTIN	D2	21	12:45
12:50	Omega	NEW CHELU	T1	8	12:50
13:00	Omega	NEW CHELU	T1	8	13:00
13:15	ExpAir	BERLIN	D2	15	13:15
13:30	Arrow	WARSAW	T1	21	13:30
13:40	AeroFlow	MADRID	T1	8	13:40
13:50	AeroFlow	TALLINN	T1	15	13:50
14:05	ExpAir	NEW YORK	T1	8	14:05
16:05	Omega	PARIS	T1	15	16:05

Talk to Our Experts

If you prefer to have ATEN contact you, please complete the form and a representative will be in touch with you shortly

First Name *

Last Name *

- Country *

Company *

Email *

Phone Number *

- Customer Type *

Job Title *



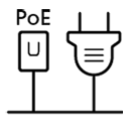

Redundancy

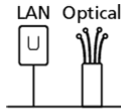

Network Redundancy



Daisy Chaining

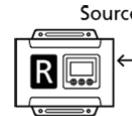

Local HDMI In

Features

Adopting advanced compression technology, the ATEN VE8962 Video over IP Extender consists of a transmitter VE8962T and a receiver [VE8962R](#) that can transmit up to 4096 x 2160 @ 60 Hz (4:4:4) HDMI, audio, USB 2.0, IR, RS-232 signals with ultra-low latency via a single Cat 5e/6 or fiber optic cable.

Additionally, the VE8962 features power redundancy with DC in and Power over Ethernet, over IP redundancy with copper cable and fiber optical cable, operation redundancy with user-friendly web GUI, and control commands by control system.

With a built-in scaler, the VE8962 can easily upscale various input resolutions up to 4096 x 2160 @ 60 Hz, giving viewers the best visual quality across all displays. Moreover, the VE8962 is capable of embedding and de-embedding audio, allowing it to be either embedded in the HDMI stream or extracted and delivered separately.

The extender supports multiple ways of controls including pushbuttons, web GUI, RS-232, bi-directional IR, and Telnet/Reslink. The VE8962 also provides users with user-friendly web GUI to customize control rooms over web for contextual and practical usage. The VE8962 supports USB 2.0 compatibility, enabling users to access USB 2.0 peripherals. For additional local input usage, the [VE8962R](#) is equipped with local HDMI input and pushbutton for easy port switching.

Engineered to meet today's demands of large scale, multi-display, True 4K signal transmission, the VE8962 supports AV matrix switch and video wall configurations with up to 80 displays, allowing you to design creative video walls, with a combination of horizontal and vertical displays.

With limitless scalability and flexibility, the VE8962 Video over IP Extender can transmit signals from floor to floor with over IP structure via simple installation, making it an ideal and reliable solution for a wide range of environments, such as trade shows, airports, university campuses, conference centers, and shopping centers.

Lightweight Compression with Ultra-low Latency

- Extends True 4K HDMI signals over IP up to 100 m point-to-point via a single Cat 5e/6 or up to 10 km via fiber optic cable with ultra-low latency
- Delivers visually lossless high-quality video up to 4096 x 2160 @ 60 Hz (4:4:4)
- Supports HDR 10 with HDCP 2.2/ 2.3 compliant for content protection
- Supports individual stereo audio and HDMI audio formats including LPCM 7.1CH, Dolby True HD, Dolby Digital Plus, and DTS-HD Master Audio
- EDID Expert. selects the optimum EDID settings for smooth power-up, high-quality display, and the best video resolution across different screens

Multiple Redundant Mechanisms

- Power redundancy – with automatic switching between DC Jack and Power over Ethernet (PoE) when both are supplied, compliant with IEEE 802.3at standard
- Over IP redundancy – transmitting the over IP signal through copper or optical fiber cable
- Operation redundancy – user-friendly Web GUI and multiple control methods

Limitless Scalability and Flexibility

- Extends AV connections from a simple point-to-point to a multi-point to multi-point setup via LAN without distance limitations
- Offers multi-functionality in extender, splitter, matrix switch, video wall, and daisy chain applications
- True 4K Scaler – converting input resolutions to optimum display resolutions
- Built-in 8KV / 15KV ESD protection
- Rack-mountable

Quick IP Setup

- Simple configuration that requires no extensive IT experience or additional learning
- Assign ID numbers for fast installation, no complex IP settings required
- Effortlessly switches among input sources via ID number of top panel push buttons

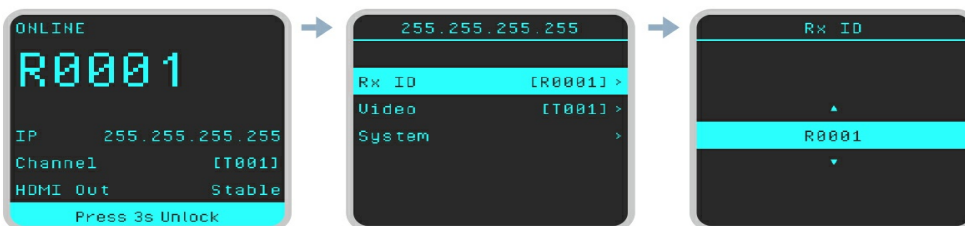

Web GUI-Based Management, No Additional Server PCs or Software Required

- Intuitive web GUI for central management and can work with all major operating systems
- Through the "Add Device" page while logging in for the first time on the web GUI, users can easily search all VE8962 devices
- Operated with imagery and contextualized web GUI, users can import environmental images to intuitively configure and organize control room layouts
- Smooth and clear 720p preview of the source on web GUI



• Spontaneous Scheduling Management

- Offers a user-friendly scheduling management function for users to pre-plan display schedule
- Provides robust and intuitive scheduling management options to help users manage all events in the calendar to as detailed as to setting events to minute intervals
- Integrates all VE8962 units to arrange profiles by grouping individual receivers or video wall
- Multiple profiles can be arranged to play in any order over a selected period of time

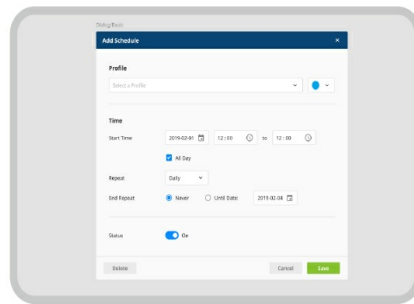

• Scalable Display Networks with Daisy Chain for Large-Scale Deployments

- Daisy chain for VE8962R up to 30 units*
- Connects multiple displays through a single port to utilize every port of the network switch and maximize their value
- Easily expandable – cabling and system deployment is easy with no huge network switches and fewer cables needed
- Perfect for large-scale deployment covering hundreds of meters through fiber optical cables, such as trade shows, airports, university campuses, conference centers, and shopping centers

Note: Only copper cable supports Daisy chain



• **Video Wall Support**

- Supports up to 8 x 10 video wall (80 displays)
- Supports horizontal or vertical (90° and 270° rotation) display orientation
- Easily switches layout profiles, previews and drag-and-drop video sources via intuitive web GUI
- Supports [boundless switching](#), enabling operators to intuitively switch control from one computer to another by moving the mouse cursor across screens*

Note: To be supported in a future firmware release.

• **Embedded / De-embedded Audio Support**

- For transmitters – separate stereo audio signals can be embedded into the HDMI stream
- For receivers – audio streams can be extracted from the HDMI stream and delivered as a separate audio signal
- Supports Audio Matrix – routes audio from selected transmitters to selected receivers, allowing flexible setup based on different unit requirements

• **Multiple Control Channels**

- Local HDMI Input – the [VE8962R](#) is equipped with a local HDMI input for quick on-site content setup from an additional local source, with easy port switching supported via the remote port selector (Part Number: 2XRT-0016G*)
- LCM display – top-panel LCM display allows for the monitoring of the ID & IP address and device status of the extender
- USB Connectivity – USB port (USB 2.0) allows for connection of devices such as keyboard, mouse, touch screen, flash drive, printer, and other USB peripherals
- Bi-directional IR Channel – IR transmission is processed one way at a time
- RS-232 Channel – bi-directional RS-232 serial port allows for connection of peripherals such as touch screens and barcode scanners
- Supports Telnet / CLI, and SSH for remote control, management, and authorized security bypass

Note: Please contact your ATEN dealer for product information.

• **Collaboration with ATEN Control System**

- Integrated solution – Compatible with [ATEN Control System](#), allowing users to directly operate [VE8962T](#) / [VE8962R](#) via CLI, Telnet, RS-232 or Reslink protocol
- Effortless Operation – Simple click to effectively operate VE Manager, TV, projector, source player, and related equipment via touch panel and keypad

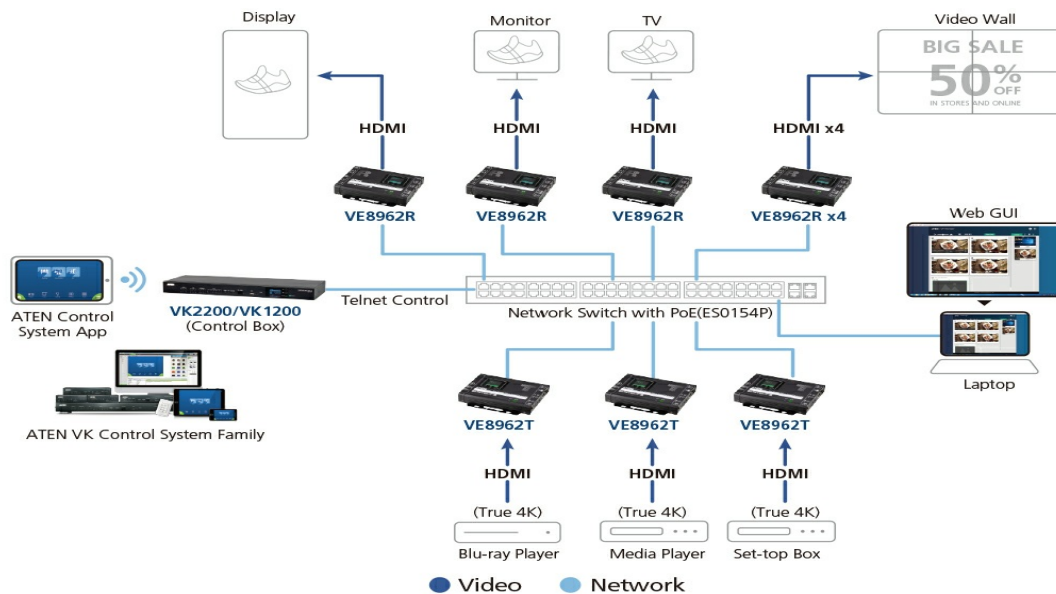

Note: VE8962 supports PoE and can be installed in combination with PoE network switches to reduce power cabling and additional power outlets. Before choosing the Network switch and installation, please refer to the Implementation Guide.

• **High-Security Protection**

- AES-256 encryption for AV streaming in SRTP (Secure Real-time Transport Protocol)
- HTTPS for secure communication

Accessories: * The power adapter and power cord for this product are sold separately. For more information about this accessory, see [Accessories](#).

Note: If you experience issues related to your network architecture, please refer to the ATEN HDMI over IP Video Extender System Implementation Guide or contact ATEN representatives for assistance.



Specifications

Video Input	
Interfaces	1 x HDMI Type A Female (Black)
Impedance	100 Ω
Max. Distance	5m
Video	
Max. Data Rate	Average: 500 ~ 800Mbps
Compliance	HDMI (4K) HDCP2.3 & HDCP2.2 Compatible
Max. Resolutions / Distance	Up to 4K@100m (Cat 5e/6, point to point) *4K supported: 4096 x 2160 / 3840 x 2160 @ 60Hz (4:4:4)
Video Compression	Optimized JPEG2000, proprietary codec
Latency	~ 1 frame
Audio	
Input	1 x HDMI Type A Female (Black) 1 x Mini Stereo Jack Female (Green)
Connectors	
Unit To Unit	1 x RJ-45 Female or 1 x SFP+ socket (SFP+ module excluded)
Power	1 x DC Jack (Black) with locking or 1 x RJ-45 (Power Over Ethernet, POE+)
Control	
IR Channel	2 x Mini Stereo Jack Female (bi-directional, Black)
RS-232	Connector: 1 x Terminal Block, 3 pole Baud Rate: 19200, Data Bits:8, Stop Bits:1, no parity and flow control
USB Channel	1 x USB Type B Female (White)
Pushbuttons	
Operating Mode Selection	3 x Push buttons for LCM operation
LEDs	
Power	1 x DC IN LED 1 x POE LED
Power Consumption	DC5V:4.35W:25BTU/h POE:5.4W:30BTU/h Note: ● The measurement in Watts indicates the typical power consumption of the device with no external loading. ● The measurement in BTU/h indicates the power consumption of the device when it is fully loaded.
Environmental	
Operating Temperature	0 - 40°C
Storage Temperature	-20 - 60°C
Humidity	0 - 80% RH, Non-Condensing
Physical Properties	
Housing	Metal
Weight	0.73 kg (1.61 lb)
Dimensions (L x W x H) with bracket	17.02 x 14.69 x 3.00 cm (6.7 x 5.78 x 1.18 in.)
Dimensions (L x W x H) without bracket	16.60 x 12.49 x 2.90 cm (6.54 x 4.92 x 1.14 in.)

Diagram

▶ Diagram

IR Emitter IR Receiver

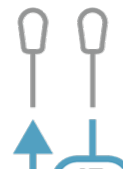

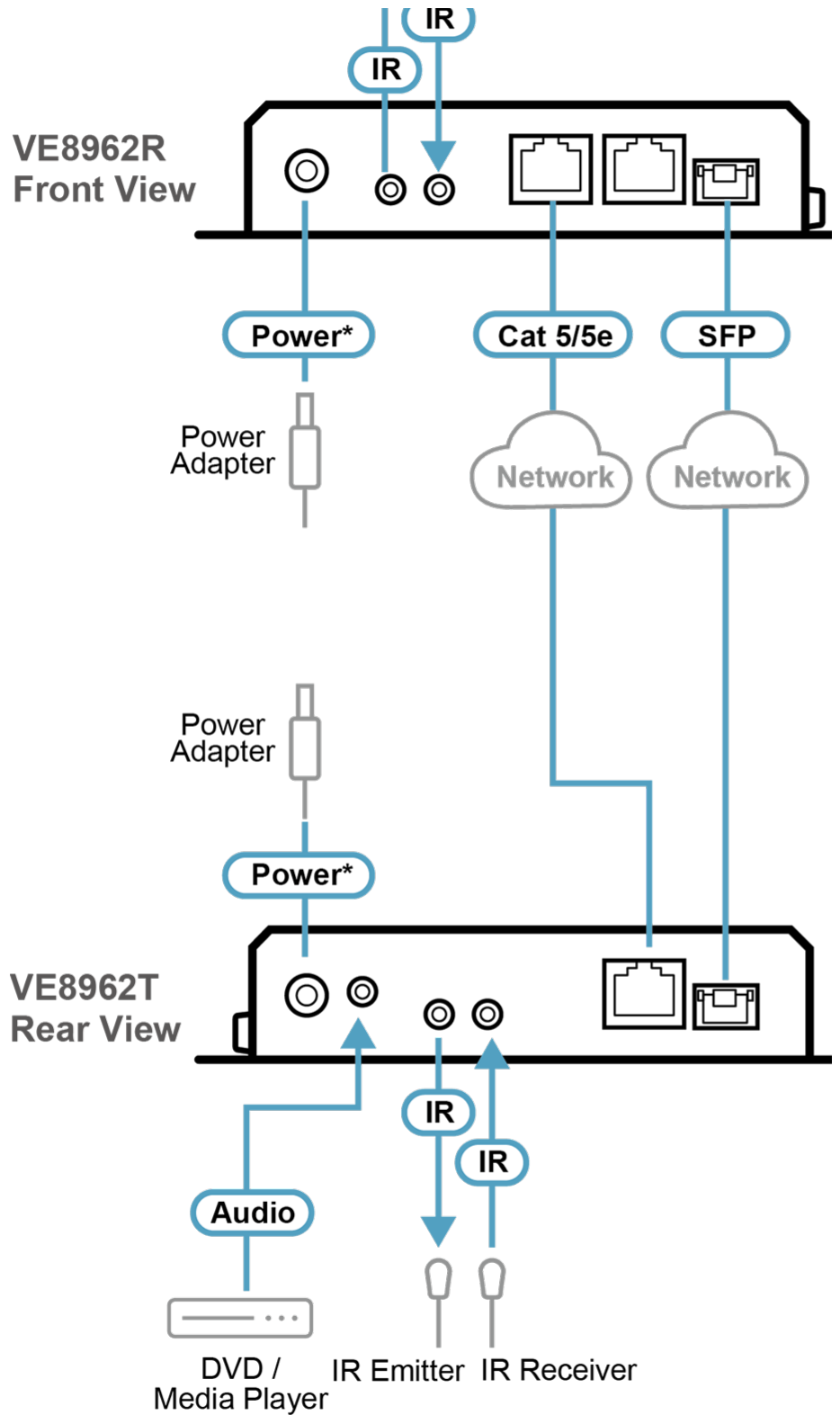

Note: The power adapter is sold separately. Please



Simply Better Connections

ATEN International Co., Ltd.

3F., No.125, Sec. 2, Datong Rd., Sijhih District., New Taipei City 221, Taiwan
Phone: 886-2-8692-6789 Fax: 886-2-8692-6767
www.aten.com E-mail: marketing@aten.com



© Copyright 2015 ATEN® International Co., Ltd.
ATEN and the ATEN logo are trademarks of ATEN International Co., Ltd.
All rights reserved. All other trademarks are the property of their
respective owners.