

CS1182DPH4

2-Port USB 5K DisplayPort/HDMI Universal Secure KVM Switch (PSD PP v4.0 Compliant)



ATEN PSD PP v4.0 Universal [Secure KVM](#) Switch CS1182DPH4 is specifically designed to meet the stringent security requirement of secure defense and intelligence installations. ATEN PSD PP v4.0 Universal [Secure KVM](#) Switch CS1182DPH4 is compliant with PSD PP v4.0 (Protection Profile for Peripheral Sharing Device, Version 4.0) standard certified by the National Information Assurance Partnership (NIAP).

ATEN PSD PP v4.0 Universal [Secure KVM](#) Switch CS1182DPH4 provides isolation between computer sources and peripherals while sharing a single keyboard, mouse, monitor, and speaker set between connected computers of various security classifications. Compliance with PSD PP v4.0 ensures peripheral sharing capabilities provide maximum user data security when switching port focus, preventing unauthorized data flows or leakage between connected sources. Key protections include isolation and unidirectional data flow, restricted peripheral connectivity and filtering, user data protection, configurable device filtration and management, strict audio filtration, and always-on tamper-proof design, keeping sensitive assets isolated and providing advanced security and a user friendly design for instantly secure deployment.

To fulfill different customer demands, ATEN PSD PP v4.0 Universal [Secure KVM](#) Switches offer a wide range of options, including 2-port and 4-port, CAC and Non-CAC models, and support for DisplayPort or HDMI interfaces through a single combo connector. ATEN PSD PP v4.0 Universal [Secure KVM](#) Switches also provide customers with the flexibility to connect single or dual displays, providing superior video quality up to 5K (5120 x 2880 @ 60Hz) ¹. 5K resolution provides greater screen real estate and sharper detail, allowing users to view multiple classified sessions, monitoring dashboards, or data-intensive applications side by side with uncompromised clarity. This enhanced visual precision helps minimize task-switching and potential errors, improving both operational accuracy and overall productivity in mission-critical or security-conscious workplaces.

To enhance security, ATEN PSD PP v4.0 Universal [Secure KVM](#) Switch CS1182DPH4 only offers manual switching methods including front panel pushbuttons and Remote Port Selector (RPS) ². With multi-layered security, ATEN PSD PP v4.0 Universal [Secure KVM](#) Switch CS1182DPH4 ensures high-level desktop security and data safekeeping for applications such as government and military agencies, healthcare providers, banking & finance institutions, and other organizations that often handle sensitive or confidential data on separate networks.

Note:

1. Supports video output resolutions up to 5120 x 2880 @ 60Hz, 5120 x 2160 @ 60Hz, 5120 x 1440 @ 60Hz/120Hz/144Hz, 3840 x 2160 @ 60Hz/120Hz/144Hz.
2. The Remote Port Selector is not supplied in the package and requires a separate purchase.



DP/HDMI Connector

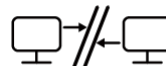

Data Channel Isolation

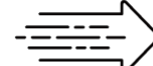

Unidirectional Data Flow



Chassis Intrusion Detection



Configurable Device Filtration



Remote Port Selector

Features

• NIAP Common Criteria Compliant

- Compliant with PSD PP v4.0 (Protection Profile for Peripheral Sharing Device, Version 4.0) security requirements
- Listed on the NATO NIAPC Product Registry

• Multi-Layered Security

- Always-on chassis intrusion detection – renders the ATEN PSD PP v4.0 Universal [Secure KVM](#) Switch series inoperable when physical tampering is detected
- Tamper-evident labels – provides visual indication of any attempt to access the ATEN PSD PP v4.0 Universal [Secure KVM](#) Switch's internal components
- Non-reprogrammable firmware – prevents reprogramming the ATEN PSD PP v4.0 Universal [Secure KVM](#) Switch's firmware
- Restricted peripheral connectivity – non-authorized HID's (Human Interface Devices), and video are rejected
- Port selection via pushbuttons / Remote Port Selector (RPS) ¹ only to enhance security
- Configurable Port LED color and Port Name Labels – easier identification between ports connected to different security classification levels
- LED indicators for peripheral filtering and KVM security status
- Strict audio filtration protects against audio leakage
- Compact size, rugged metal enclosure

• Data Channel Isolation and Unidirectional Data Flow

- True data path isolation – data cannot be transferred between computers
- The ATEN PSD PP v4.0 Universal [Secure KVM](#) Switch controls and isolates data flow between the console devices and connected computers
- Unidirectional data flow between console devices and the selected computer is ensured
- Supports analog audio (speaker only) ² via isolated audio paths
- Supports DisplayPort (or HDMI) embedded digital audio

• User Data Protection

- The ATEN PSD PP v4.0 Universal [Secure KVM](#) Switch's keyboard/mouse data is automatically deleted after transmission and automatically purged when the KVM port focus is switched

• Security Management

- Supports administrative configuration of keyboard / mouse ports filtering to reject specific USB HID devices
- Provides administrative functions for authorized administrators to audit KVM log data

• Superior Video Quality and Flexible Connectivity

- Superior video quality – up to 5K (5120 x 2880 @ 60Hz) ³
- DisplayPort / HDMI combo connectors support DisplayPort and HDMI video interfaces (both PC and Console sides)
- Video DynaSync™ – exclusive ATEN technology eliminates boot-up display problems and optimizes resolutions when switching among different sources

Note:

1. The Remote Port Selector is not supplied in the package and requires a separate purchase.
2. Only analog speaker data input is supported.
3. Supports video output resolutions up to 5120 × 2880 @ 60Hz, 5120 × 2160 @ 60Hz, 5120 × 1440 @ 60Hz/120Hz/144Hz, 3840 × 2160 @ 60Hz/120Hz/144Hz

Specifications

Computer Connections	2
Port Selection	Pushbutton, Remote Port Selector
Connectors	
Console Ports	1 x DP/HDMI Female (Black) 2 x USB Type-A Female (White) 1 x Mini Stereo Jack Female (Green; 1 x front)
KVM Ports	2 x DP/HDMI Female (Black) 2 x USB Type-B Female (White) 2 x Mini Stereo Jack Female (Green)
Power	1 x DC Jack
Remote Port Selector	1 x RJ-11 (Black; 1 x rear)
Switches	
Port Selection	2 x Pushbuttons
Reset	1 x Semi-recessed Pushbutton
Power	1 x Pushbutton
LEDs	
Power	1 (Green)
Online / Selected (KVM Port)	2 (Orange / Green)
Video	1 (Green)
Key Lock	3 (Green)
Emulation	
Keyboard / Mouse	USB
Video	Max. 5120 x 2880 @ 60Hz, 5120 x 2160 @ 60Hz, 5120 x 1440 @ 60Hz/120Hz/144Hz, 3840 x 2160 @ 60Hz/120Hz/144Hz
Maximum Input Power Rating	100-240V~; 50-60 Hz; 1.2A
Power Consumption	DC12V:12.48W:102BTU/h Note: ● The measurement in Watts indicates the typical power consumption of the device with no external loading. ● The measurement in BTU/h indicates the power consumption of the device when it is fully loaded.
Environmental	
Operating Temperature	0-40°C
Storage Temperature	-20-60°C
Humidity	0 - 80% RH, Non-condensing
Physical Properties	
Housing	Metal
Weight	1.21 kg (2.67 lb)
Dimensions (L x W x H)	24.50 x 14.36 x 4.30 cm (9.65 x 5.65 x 1.69 in.)
Note	For some of rack mount products, please note that the standard physical dimensions of WxDxH are expressed using a LxWxH format.

Diagram

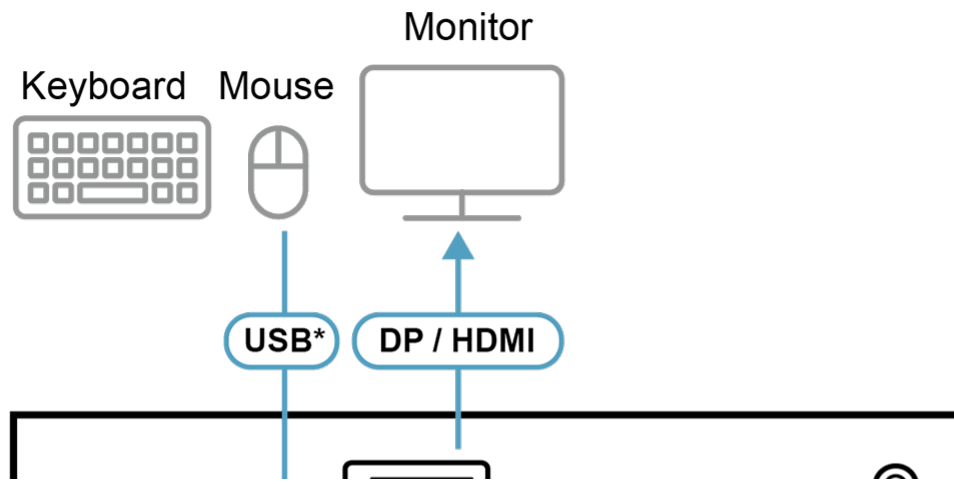

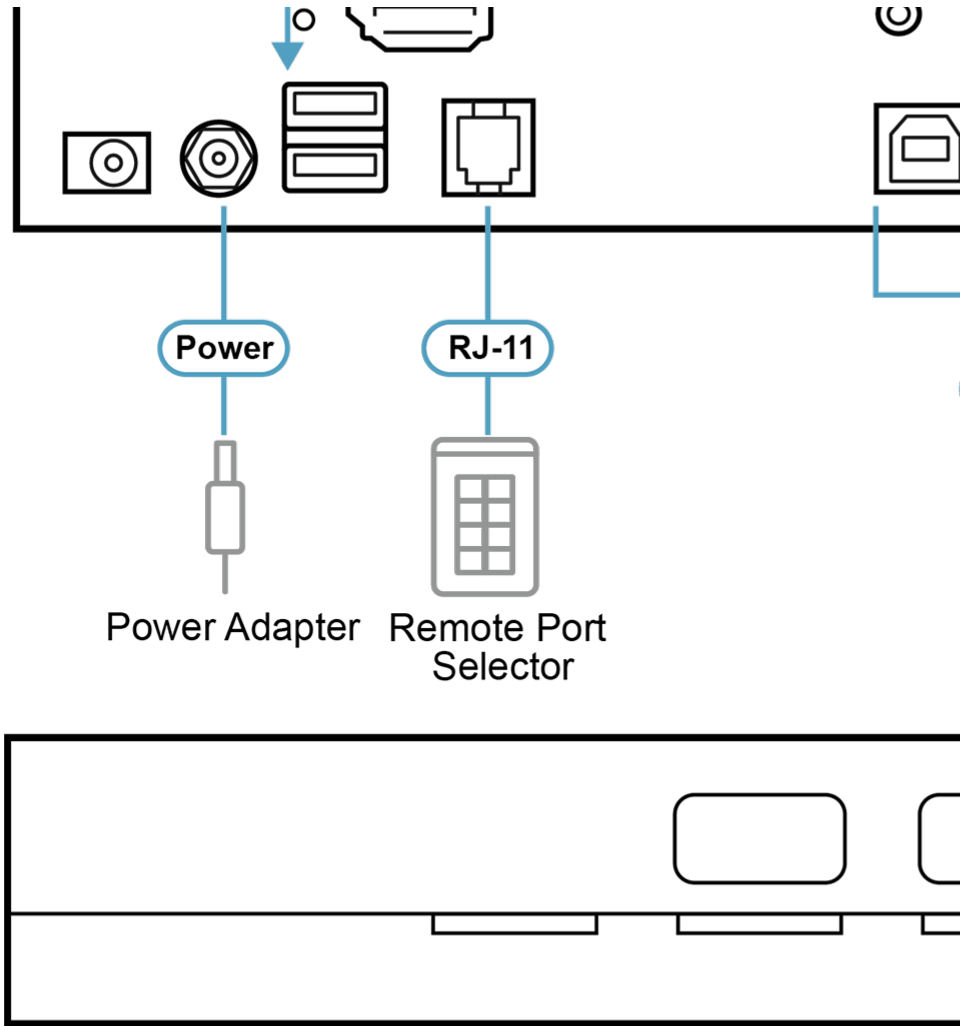

*USB Keyboard / Mouse

