

## CS1922M

2-Port USB 3.0 4K DisplayPort MST KVMP™ Switch (Cables included)



Incorporating the latest [Multi-Stream Transport \(MST\)](#) technology, the CS1922M 2-Port USB 3.0 4K DisplayPort [MST KVMP™](#) Switch is the world's first [DisplayPort KVM switch](#) with a built-in [MST](#) hub. The CS1922M enables users to adopt two console displays from a single [DisplayPort 1.2](#) video source, providing an extended desktop mode and splitter mode at resolutions up to 4K for multitasking across two displays while reducing bulky cable connections.

To meet the ever-increasing demand for high-speed peripheral data transmissions, the CS1922M integrates a USB 3.1 Gen 1 hub to deliver unprecedented data transfer rates up to 5 Gbps – allowing you to maximize multitasking operations.

The unique independent switching feature allows the KVM switch's focus to be on one computer while its USB peripheral focus is on another computer. This eliminates the need to purchase a separate USB hub or stand-alone peripheral sharer – such as a print server or splitter. Additionally, the switch allows you to share the audio from each of the connected computers and even allows HD audio transmitted through a DisplayPort source.

With a rich feature set, the CS1922M is designed to exceed the requirements such as excellent video quality and ultra-fast data transmission speed for gaming, graphic design, animation, and video-editing applications.



## Features

- **World's First DisplayPort KVM Switch with Built-in MST Hub**
  - One USB keyboard/mouse and DisplayPort or HDMI monitor control 2 computers and 2 USB peripherals
  - Built-in [Multi-Stream Transport \(MST\)](#) hub allows dual displays (DisplayPort / HDMI) from a single DisplayPort source <sup>1</sup>
  - Supports [MST](#) Mode, Splitter Mode, and Single Port Mode.
  - 2-port USB 3.1 Gen 1 hub with SuperSpeed 5 Gbps data transfer speeds
  - DisplayPort Dual-Mode (DP++) technology supports HDMI and DVI signals via a DisplayPort-to-HDMI/DVI DP++ adapter <sup>2</sup>
  - Firmware upgradeable
  - Hot pluggable – add or remove computers without powering down the switch
  
- **Remarkable Audio/Video Experience**
  - Superior video quality – 4K UHD (3840 x 2160 @ 60 Hz) and 4K DCI (4096 x 2160 @ 60 Hz)
  - DisplayPort 1.2 compliant, HDCP 1.3 compliant <sup>3</sup>
  - Supports HD audio through DisplayPort <sup>4</sup>
  - Full bass response for high-quality 2.1 channel surround sound systems
  
- **Intelligent Operation**
  - Computer selection via front panel pushbuttons, hotkeys, mouse <sup>5</sup>, and RS-232 commands
  - Independent switching of KVM, USB hub, and Audio focus
  - Power On Detection – if a computer is powered off, the CS1922M automatically switches to the next powered-on computer
  - Auto Scan Mode for monitoring all computers
  
- **Versatile Compatibility**
  - Keyboard emulation/bypass feature supports most gaming keyboards
  - Mouse emulation/bypass feature supports most mouse drivers and multifunction mice
  - Multi-platform support – Windows, Mac and Linux
  - Multilingual keyboard mapping supports English, Japanese, French and German keyboards

### Note:

1. [MST \(Multi-Stream Transport\)](#) requires either monitors that are capable of [DisplayPort 1.2](#) daisy-chaining, or use of a powered DisplayPort [MST](#) Hub. A DisplayPort v1.1a display can be the last display in a DisplayPort v1.2 chain. The PC source must be [DisplayPort 1.2](#) compliant
2. DisplayPort Dual-Mode technology (DP++) does not require an active adapter for most single display setups.  
Active DisplayPort adapters are recommended if you are unsure of the video source's DP++ compatibility.
3. For DisplayPort 1.4 compliant display device, make sure to configure the device setting to be compatible with [DisplayPort 1.2](#) to avoid compatibility issue.
4. HD audio through DisplayPort cannot be switched independently.
5. Mouse port switching is only supported under mouse emulation mode with a USB 3-button mouse wheel.

**Specifications**

Computer Connections	2
Port Selection	Hotkey, Pushbutton, Mouse, RS-232 Commands
Connectors	
Console Ports	2 x USB Type A Female 1 x DisplayPort Female (Black) 1 x HDMI Female (Black) 2 x 3.5mm Audio Jack Female (Green; 1 x front, 1 x rear) 2 x 3.5mm Audio Jack Female (Pink; 1 x front, 1 x rear) 1 x RJ-11 Female
KVM (Computer) Ports	2 x USB3.1 Gen1 Type B Female (Blue) 2 x DisplayPort Female (Black) 2 x 3.5mm Audio Jack Female (Green) 2 x 3.5mm Audio Jack Female (Pink)
Power	1 x DC Jack
USB Hub	2 x USB3.1 Gen1 Type A Female (Blue; 1 x front panel; 1 x rear panel)
Switches	
Selected	2 x Pushbutton
LEDs	
On Line /Selected	2 (Orange)
USB Link	2 (Green)
Emulation	
Keyboard / Mouse	USB
Video	Up to 4096 x 2160 @ 60Hz, 2560 x 1440 @ 144Hz
Scan Interval	1-99 seconds (Default: 5 seconds)
Power Consumption	DC5V:4.09W:62BTU/h  <b>Note:</b> <ul style="list-style-type: none"> <li>● The measurement in Watts indicates the typical power consumption of the device with no external loading.</li> <li>● The measurement in BTU/h indicates the power consumption of the device when it is fully loaded.</li> </ul>
Environmental	
Operating Temperature	0-50°C
Storage Temperature	-20-60°C
Humidity	0-80% RH, Non-condensing
Physical Properties	
Housing	Metal, Plastic
Weight	0.73 kg ( 1.61 lb )
Dimensions (L x W x H)	21.00 x 8.80 x 5.55 cm (8.27 x 3.46 x 2.19 in.)
Note	For some of rack mount products, please note that the standard physical dimensions of WxDxH are expressed using a LxWxH format.

Diagram

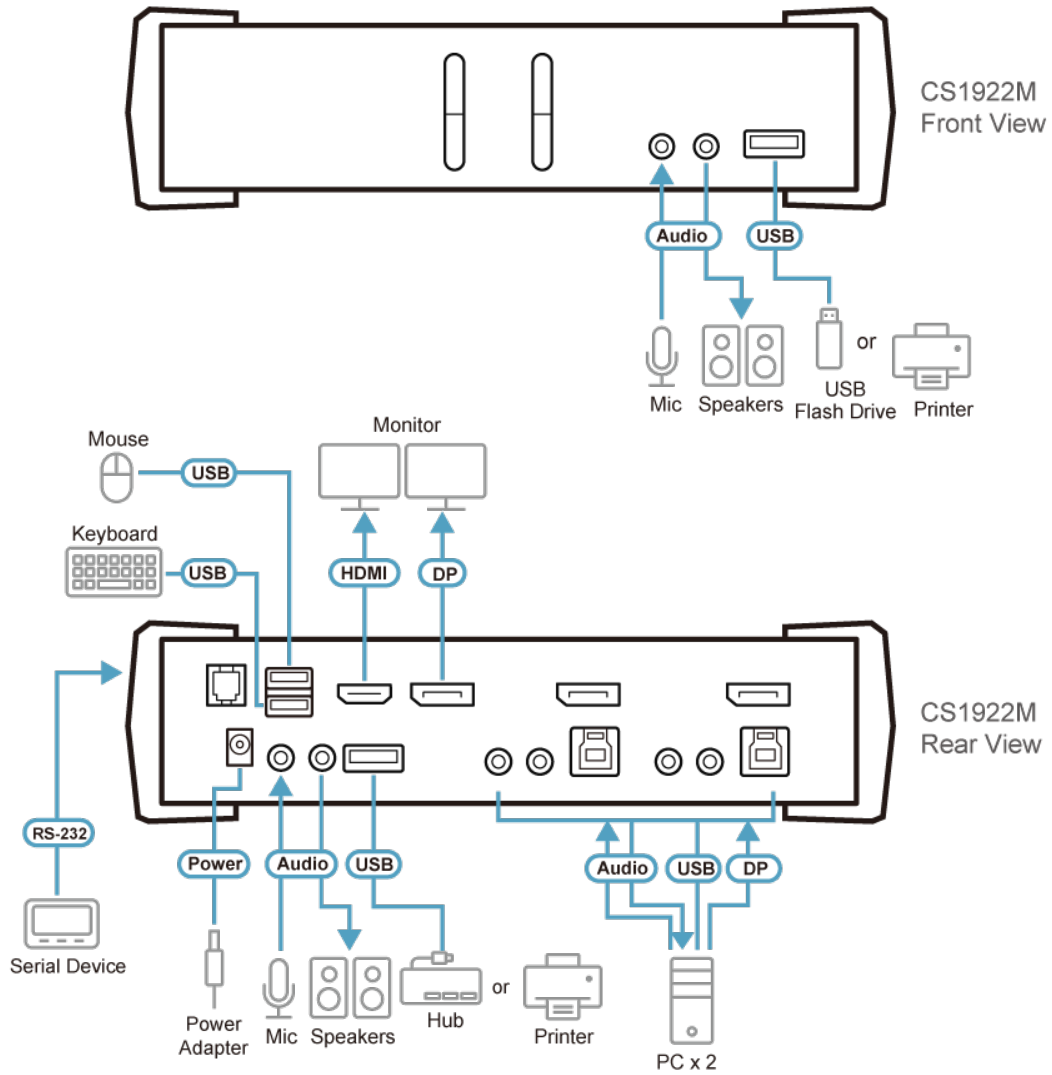

**ATEN International Co., Ltd.**

3F., No.125, Sec. 2, Datong Rd., Sijhih District., New Taipei City 221, Taiwan  
 Phone: 886-2-8692-6789 Fax: 886-2-8692-6767  
 www.aten.com E-mail: marketing@aten.com



© Copyright 2015 ATEN® International Co., Ltd.  
 ATEN and the ATEN logo are trademarks of ATEN International Co., Ltd.  
 All rights reserved. All other trademarks are the property of their respective owners.