

## KG0016

16-Port KVM over IP OmniBus Gateway



# All-Digital KVM over IP Server Room Management Solution

Speedy & Uninterrupted Server Uptime with Crystal-Clear Visualization

Advanced Noise Immunity for Superior Digital Signal Transmission

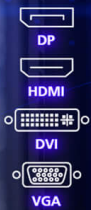

DigiProcessor with 0U Housing

DigiKVM™

All-Digital KVM over IP OmniBus Gateway

**2x** Longer  
Server Cabling Connection (up to 100m)

**10x** Faster  
Virtual Media Data Transfer Rate

**100x** Greater  
Livestreamed Video Refresh Rate

Panel Array Mode Live+ with Livestreamed Video

9 606.10  
Analytics

Crystal-Clear Video

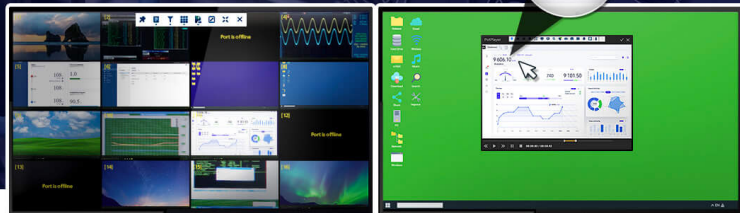

#### Distortion Free

- Strengthened KVM Ports with Enhanced High-Voltage Isolation and Suppressed Electromagnetic Interference

#### Delay Free

- Real-time and Concurrent Remote Access, Anywhere and Anytime

#### 10x Faster

- Superb Virtual Media Data Transfer Rate for Prompt Server Updates

#### 100x Greater

- Superior Livestreamed Video Refresh Rate with Panel Array Mode™ Live+

#### Agile & Effortless Installation

- Industry's Most Compact KVM DigiProcessor to Maximize Rack Space Efficiency

Sustainability is pivotal in modern business, with IT/OT convergence at the forefront of innovation. This union not only heightens competitiveness but also enhances responsiveness to market demands, particularly concerning data security and network uptime. With the rise of digitalization in industry, cybersecurity's role in bolstering IT-OT synergy is crucial.

The DigiKVM™ – KG0016/[KG0032](#) exemplifies this digital shift. This all-digital KVM over IP OmniBus Gateway champions digital transformation in spaces like server rooms and data centers. Through a secure portal, it offers centralized management and real-time remote server access. Regardless of the data signal type from the linked KVM DigiProcessor, all transmissions are digitized and protected, ensuring fast, clear video monitoring with remarkable visual accuracy.

The all-digital KVM over IP solution stands out for its robust security and versatile OS compatibility. It also presents a reliable way to manage remote IT access with out-of-band (OOBM) connection, especially when the in-band connectivity is compromised. For geographically spread businesses, it's a boon, enabling IT to quickly reinstate services and minimize business downtime.

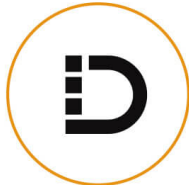

All-digital  
KVM over IP



Video Clarity

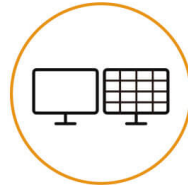

100x Livestreamed  
Video Refresh Rate

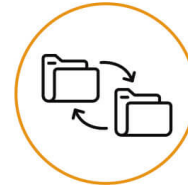

10x Virtual Media  
Data Transfer Rate



2x / 100m  
Server Cabling Connection



HTML5 WebClient



TLS 1.3/FIPS 140-3  
Encryption

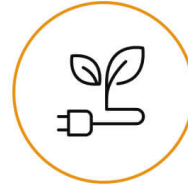

Low Power  
Consumption

**Distortion Free**

**Strengthened KVM Ports with Advanced High-Voltage Isolation and Suppressed Electromagnetic Interference**

All KVM Ports from both the KVM DigiProcessor or KVM over IP OmniBus Gateway are equipped with advanced high-voltage isolation and noise filtering that help suppress electromagnetic interferences thereby safeguarding against factors such as lightning strike that could potentially cause significant damage to the chip. This enhancement ensures that digital KVM over IP transmission maintains signal integrity and reliability in network communication.



**ISO/IEC 27002:2022 Compliance. BIOS-Level Remote Security**

The KVM over IP OmniBus Gateway provides a secure, hardware-based KVM over IP solution with direct, hack-proof BIOS-level control. Unlike software tools such as VNC or RDP, it eliminates OS-level vulnerabilities while ensuring compliance with ISO/IEC 27002:2022 Control 6.7 on Remote Working – safeguarding the confidentiality, integrity, and availability of sensitive data, processes, and systems in mission-critical environments. (Discover the KG Series in action with [EVA Air's success story](#))



**Industry-First FIPS 140-3 Secured All-Digital KVM over IP Transmission**

The KVM over IP OmniBus Gateway, operating within a closed system, provides a single secure portal to centralize BIOS-level connections to PCs and servers – without requiring additional software installation or configuration. As the industry’s first all-digital KVM over IP solution to implement FIPS 140-3 and TLS 1.3 encryption, it safeguards data transmission and ensures secure access to all remote servers via a Java-free HTML5 WebClient Viewer or a WinClient Viewer.

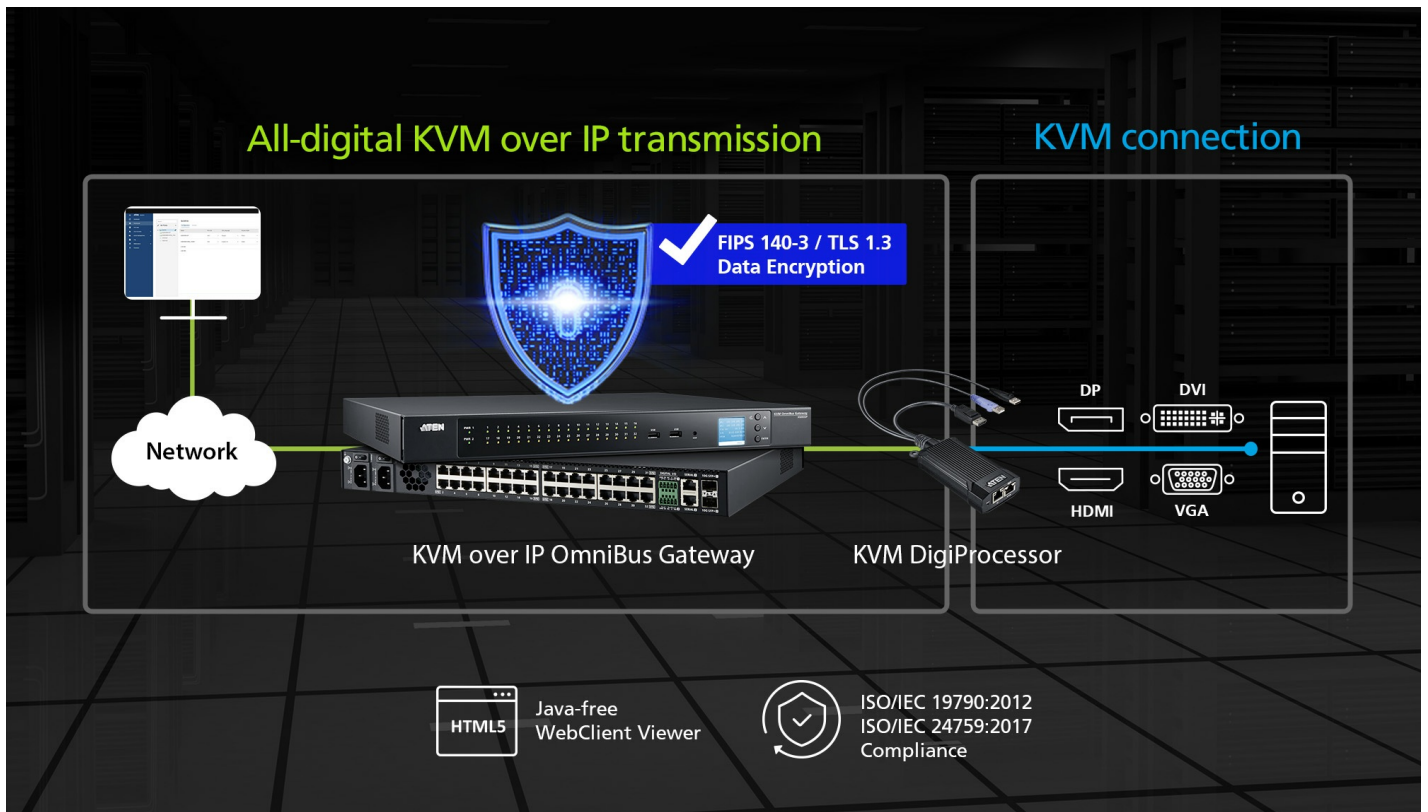

**Real-time and Concurrent Remote Access, Anywhere and Anytime**

The All-digital KVM over IP OmniBus Gateway allows real-time, up to 32 concurrent remote user access to any connected servers regardless where and when the login takes place. Server connection can be extended up to 100m away, delivering extraordinary 4K visual clarity and agile user experience with smooth keyboard-video-mouse synchronization.



**10x Faster**

**Superb Virtual Media Data Transfer Rate for Prompt Server Updates**

Mapping media to a remote server as though it were saved locally does the trick for timely troubleshooting, reducing travel cost and minimizing MTTR (Mean Time to Repair). With a superb data transfer rate (i.e. Read: 265 Mbps, Write: 188 Mbps) proven to be 10 times faster than standard KVM over IP switches, performing firmware upgrades, diagnostic tests, file transfers, and installing software and application patches can all be accomplished smoothly and quickly from a single console located anywhere.



**100x Greater**

**Superior Livestreamed Video Refresh Rate with Panel Array Mode™ Live+**

Real-time monitoring is effortless with [Panel Array Mode™ Live+](#) where content of a dedicated server is displayed in 24-bit true color and up to 3840 x 2160 @ 30Hz in a control-view window, while the video from all servers is presented in a [multi-view](#) grid layout which is variable as needed (up to 4x4 with [KG0016](#) or 4x8 with [KG0032](#)). The video feed in both the control and array views is livestreamed with a refresh rate significantly 100 times greater, providing extraordinary smoothness for optimized situational awareness, when compared to standard KVM over IP switches.

**Agile and Effortless Installation**

**Industry's Most Compact KVM DigiProcessor to Maximize Rack Space Efficiency**

The 0U-housed KVM DigiProcessor, available in VGA, DVI, HDMI, and DisplayPort connectivity, is 25% lighter and ¼ the size of comparable products, offering flexible, optimized in-rack server connections and straightforward installation without requiring additional adapters. The anti-bending SR hanger allows for flexible yet stable in-rack installation, while the indented groove on both sides is intended to prevent the device from falling loose when tied onto the rack. In addition, the heat radiating fins are purposed to boost airflow efficiency to ensure system reliability.



**Accelerating Digitalization via Digital Twin Model**

With the deployment of the KVM over IP OmniBus Gateway and the KVM DigiProcessor, equipment data collected in the production line can be monitored and processed in real time via a remote console, preventing the need to constantly enter the production line or clean room for operations. This approach facilitates manufacturing digitalization via setting up a digital twin model to streamline and optimize production line processes.

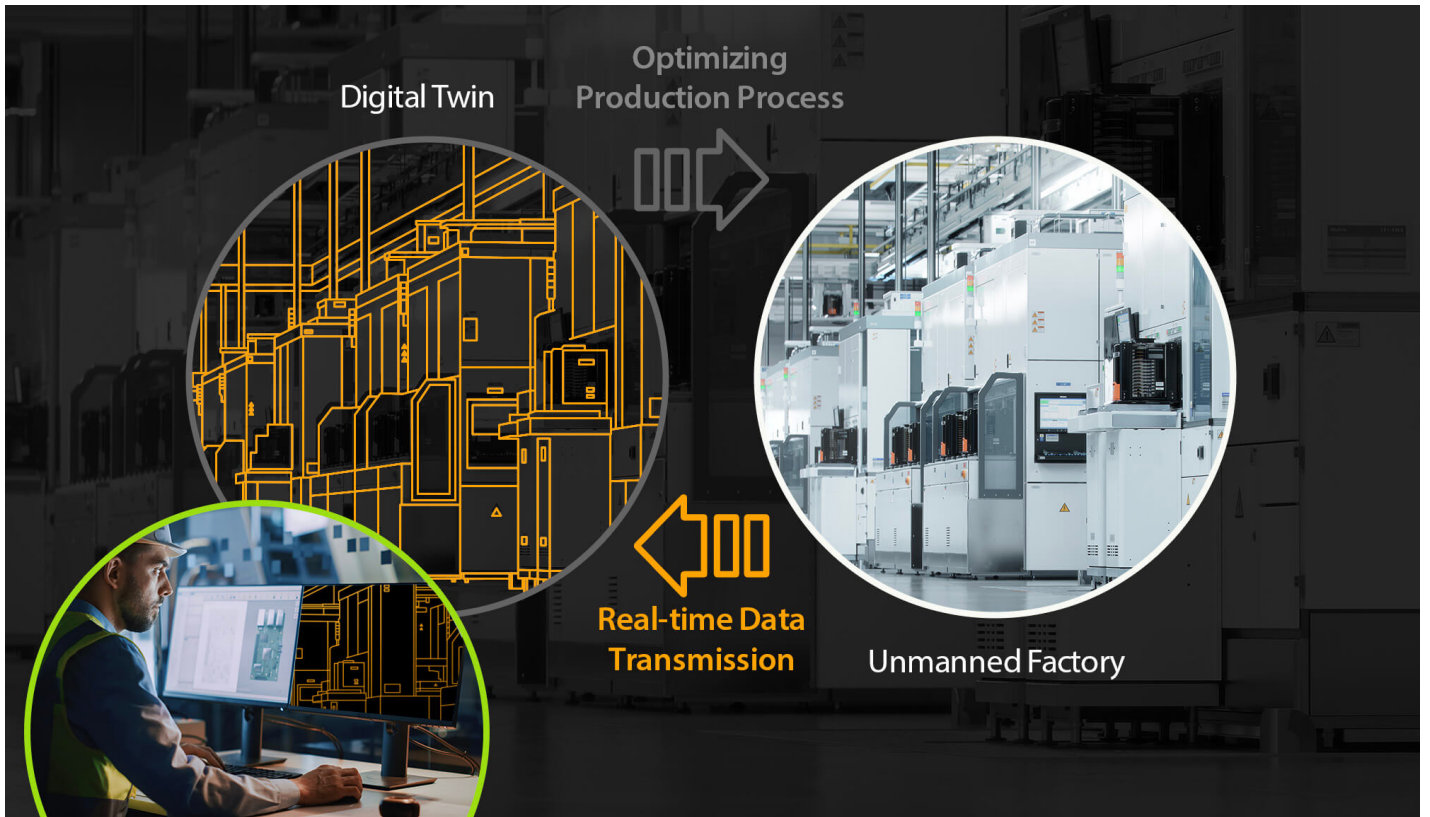

**Out-of-Band Management for Any Contingency**

With the management network and production network separated, the KVM over IP OmniBus Gateway connected to the management network allows the IT operator to perform timely troubleshooting (e.g. software patches, image updates, reboots, etc.) and system maintenance over the servers via BIOS during the downtime of the production network. This approach can serve as an emergency measure in contingencies while keeping data and workflow secure from end to end.

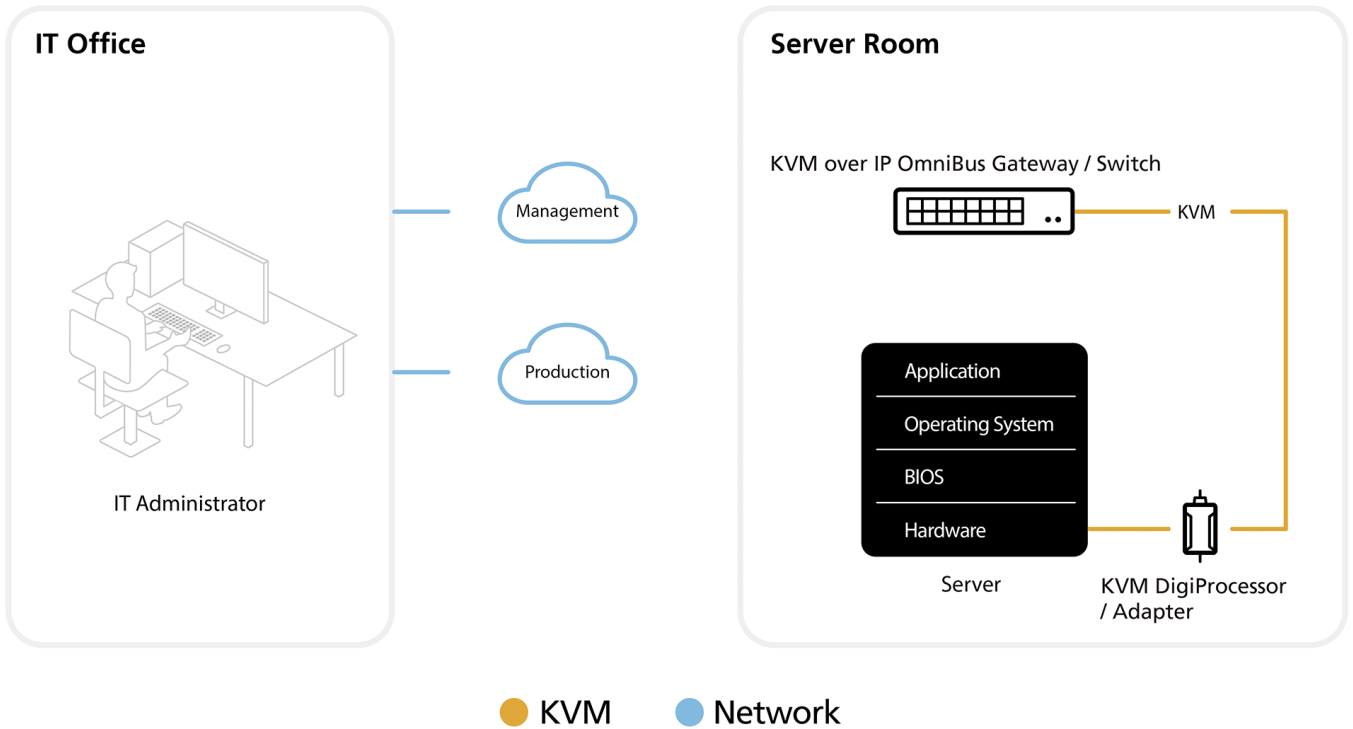

**Superior Hardware Performance to Reinforce System Reliability and Usability**

The KVM over IP OmniBus Gateway is built in with 4x server-grade smart fan modules, facilitating all-around airflow efficiency for strengthened system reliability. When the system is idle or under light workload, the fan then runs in a low hum under 40 dBA. In addition, the front panel pushbuttons can be used to perform timely troubleshooting with prompt device configuration and system reboot in contingencies, and also locked to secure system settings from unauthorized access.

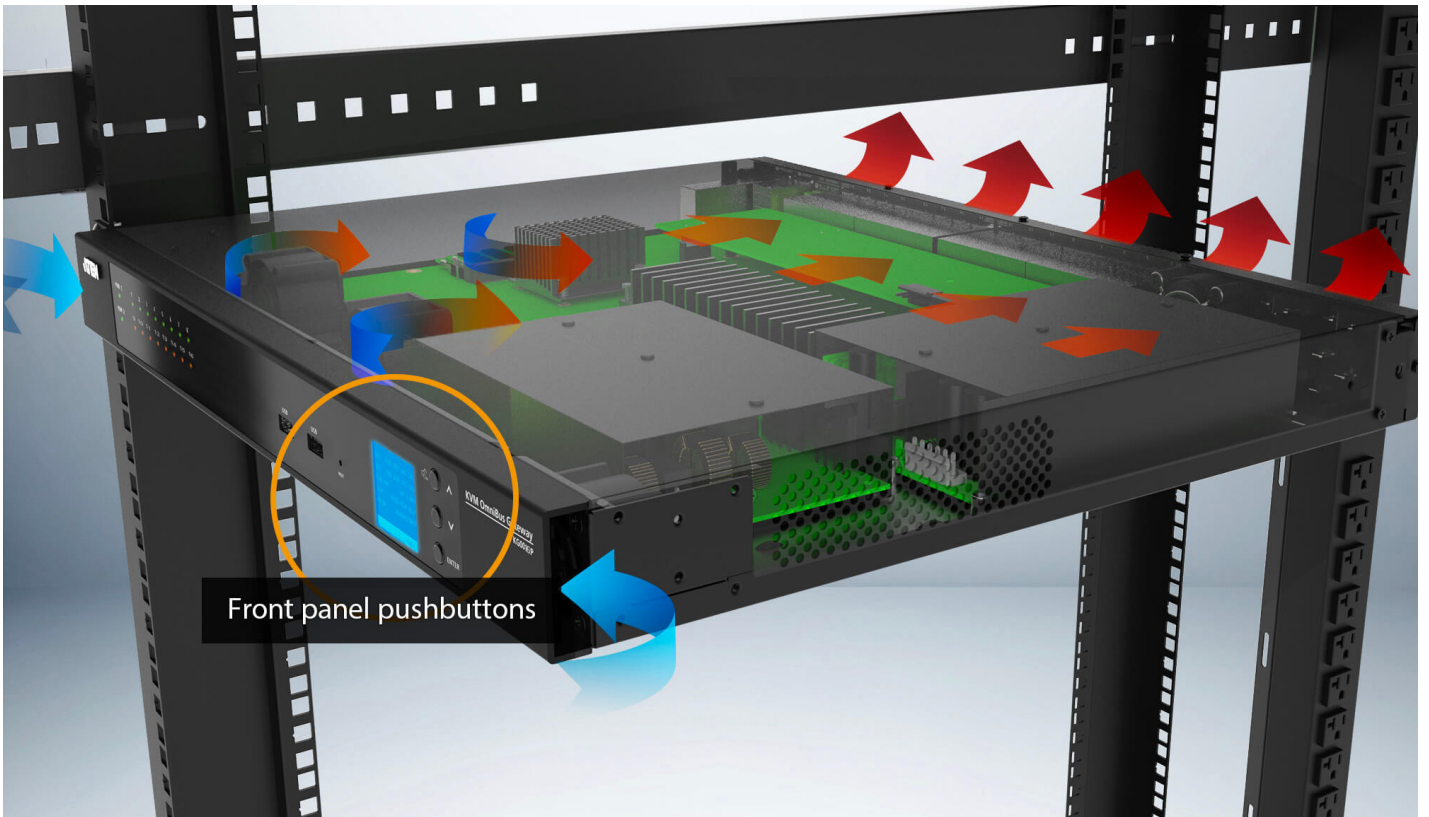

## Applications

The All-Digital KVM over IP solution facilitates seamless IT/OT convergence with comprehensive server management, and is perfectly suited to various industrial applications that are accelerating towards digital transformation.

**IT Infrastructure Management**

- BIOS level access
- Superb Virtual Media read/write data transfer rate
- TLS 1.3 & FIPS140-3 encryption

**Information Visualization**

- Up to 16 concurrent remote user access to any connected server
- Real-time remote monitoring and control
- Panel Array Mode Live+ with livestreamed video feed



Production Automation

- Delay-free Remote Control
- Real-time remote monitoring and equipment access
- Panel Array Mode Live+ with livestreamed visuals from production line equipment

**Remote Monitoring & Control**

- Up to 16 concurrent remote user access to any connected server
- Panel Array Mode Live+ with livestreamed video feed
- Superb Virtual Media read/write data transfer rate



**Product Comparison**

**Talk to Our Experts**

**If you prefer to have ATEN contact you, please complete the form and a representative will be in touch with you shortly**

## Features

The KG0016 16-Port KVM over IP OmniBus Gateway provides remote over IP access, allowing users to access, monitor, and control up to 16 servers over a network. With KG0016 independent remote connections, it ensures higher operation efficiency and optimizes the user experience by eliminating waiting time and bus sharing. This single management platform connects servers through a single secure portal, simplifying access and control for efficient administration. With its all digital KVM over IP architecture, the KG0016 prevents video lagging and freezing, ensuring stable and smooth video display, particularly in long-distance extension application. Equipped with dual on-board 10G NICs<sup>1</sup> for redundancy, this series is built to guarantee reliability and availability of remote access to all servers. The virtual media transmissions are faster than traditional KVM over IP switches, allowing for the completion of a 1GB file transmission in just one minute. When the KG series works with the KVM DigiProcessor series ([KG8950T / KG9950T / KG1900T / KG6900T / KG8900T / KG9900T](#)), it delivers superior video resolutions up to 3840 x 2160 @ 30 Hz ([KG8950T / KG9950T](#)) or 1920 x 1200 @ 60 Hz ([KG1900T / KG6900T / KG8900T / KG9900T](#)), for distances up to 100 meters over a single Cat 5e/6 cable.

The KG series can be remotely accessed via WinClient AP or HTML5 WebClient<sup>2</sup> at a console from a separate location for management and operation. The WinClient AP comes with complete KVM functions and provides users with continuous, reliable connections. It can help users to simultaneously monitor the status of all connected servers on Array View and control a specific server through Control View. For basic KVM functions, users can directly access and control one of the ports through the HTML5 WebClient by simply launching a client viewer from a browser, without the need for pre-installed software. Additionally, it allows users to easily separate the client viewer from the browser and drag it to a second monitor for control while monitoring the status of all ports on the Port View from Web GUI.

This KVM over IP OmniBus Gateway allows out-of-band access to connected servers from remote consoles via the management network for BIOS-level troubleshooting when the production network is down. It enables IT administrators to manage servers via management networks that are separated from the main / production networks. If there's difficulty in accessing the servers through the production network, administrators can still access servers via KG series. To ensure robust security, the KG series features TLS 1.3 and an embedded FIPS 140-3 certified OpenSSL cryptographic module – delivering advanced encryption and enabling secure deployment across highly regulated sectors such as government, defense, healthcare, utilities, and finance. Additional security features include 256-bit AES encryption for data protection and support for third-party authentication via RADIUS, LDAP, LDAPS, and Microsoft Active Directory.

The KG series can be integrated into ATEN's [CC2000](#) Centralized Management Software and [CCVSR](#) Video Session Recording Software. [CCVSR](#) securely records and plays back all screen activity – including BIOS-level operations – on computers accessed via KVM over IP switches, for auditing and troubleshooting. The [CC2000](#) delivers a better user experience and advanced usability. By utilizing consolidated data, task-based navigation, and simplified menus, administrators can access, configure, and manage all of the IT equipments with ease.

Additional exclusive features of KG series include a Message Board, Panel Array Mode™ Live+, Mouse DynaSync™, and a front panel LCD display. ATEN KVM over IP OmniBus Gateway saves users time and money by enabling administrators to manage their servers from virtually anywhere – minimizing travel and MTTR (Mean Time to Repair) costs, ensuring the highest availability for data center services.

### Note:

1. Fiber or copper SFP modules are sold separately. Please find them on the compatible accessories list and order with KG devices together.
2. We recommend using the WinClient app for more robust management and control. Performance and usage may vary depending on the user's hardware configuration. A minimum of 8 GB RAM, dual core CPU, and a graphics card that supports OpenGL are required. Please also make sure that the browser used is up to date.

## • Hardware

- High port density – RJ-45 connectors and Cat 5e / 6 cable for up to 16 ports in 1U housing
- All-digital KVM over IP optimum transmission – offers reliable transmission over long distances with noise immunity, signal quality preservation, and efficient compression and storage
- Extends 3840 x 2160 @ 30 Hz resolutions up to 100m via Cat 5e/6 without signal interference and close-to-zero latency (video resolution varies depending on the DigiProcessor)
- Up to 16 independent connections for remote KVM over IP access
- Dual 10G NICs for redundant LAN or two IP operation
- LCD display – provides real-time connection status, notifications, and system alert message
- LED indication of connection and hardware status
- Multi-platform server environments: Windows, Mac, and Linux
- All-around ventilation chassis design improves airflow efficiency – induces cold air suction on both sides at the front panel and dissipates heat via ventilation holes on the back panel
- Dual power supply with power redundancy

## • Management

- Simultaneously shares 16 independent connections to the attached servers
- Out-of-Band access

- Integration with ATEN [CC2000](#) Centralized Management Software and [CCVSR](#) Video Session Recording Software
- Green IT Fan – auto-fan-speed adjustment corresponding to temperature
- Event logging and Windows-based log server
- Event notification – supports notification of SMTP email, SNMP Trap, and SMS (with additional mobile devices)
- Event destination – event logs will be saved to Log server, Syslog server, and USB drive
- Firmware upgradeable
- Port share mode – allows multiple users to gain access to a server simultaneously
- Supports IPv4, IPv6
- Supports ATEN KVM over IP console station (KA82xx series)

• **Easy-to-Use Interface**

- The intuitive WinClient AP's supports of an Array View and a Control View – enables users to monitor all servers and control a specific server concurrently
- Panel Array Mode™ Live+ – real-time monitoring of livestreamed video feeds from all ports in a configurable multiscreen layout
- Browser-based, and AP GUIs offer a unified multi-language interface to minimize user training time and increase productivity
- Multiplatform client support (Windows, Mac OS X, and Linux) via WebClient
- Multi-browser support – Edge, Chrome, Firefox, Safari, and Opera
- Supports web-friendly KVM-over-IP access with HTML5 WebClient viewer – users can remotely access all the connected servers and PCs without Java or browser plug-in installation
- Full-screen or sizable and scalable virtual remote desktop

• **Security**

- High-grade security – supports an embedded FIPS 140-3 certified OpenSSL cryptographic module (Certificate #4985)
- Remote authentication support: RADIUS, LDAP, LDAPS, and MS Active Directory
- Supports TLS 1.3 data encryption and RSA 2048-bit certificates to secure user logins in from browser
- Flexible encryption design allows users to choose any combination of 56-bit DES, 168-bit 3DES, 256-bit AES, 128-bit RC4, or random for video, and virtual media data encryption
- Support for IP / MAC filter
- Configurable user and group permissions for server access and control
- Automated CSR creation utility and third party CA certificate authentication

• **Virtual Media**

- Virtual media transmission rate is approximately 10 times faster than traditional KVM, ideally for file transfers, OS patching, software installation, and diagnostic testing
- Works with USB-enabled servers in operating system and at the BIOS level
- Supports USB2.0 DVD / CD drives, USB mass storage devices, PC hard drives, and ISO images

• **Virtual Remote Desktop**

- Video quality such as monochrome color depth and bandwidth's increment / decrement can be adjusted for optimizing data transfer speed
- Mouse DynaSync™ – automatically synchronizes remote mouse movements
- On-screen keyboard with multi-language support
- BIOS-level access for troubleshooting

**Specification**

Console Connections	
Local	N/A
Remote	16
Computer Connections	
Direct	16
Port Selection	GUI
Connectors	
USB Port	2 x USB Type-A Female (Reserved for futuer expansion)
KVM Ports	16 x RJ-45 Female
SFP+ Uplink Ports	2 x SFP+ Slots *
Serial	2 x RJ-45 Female (Reserved for future expansion)
Power	2 x IEC 60320/C14
Input	2 x 2-pin DI (Reserved for future expansion)
Relay	2 x 3-pin Relay (Reserved for future expansion)
Switches	

Reset	1 x Semi-recessed Pushbutton
Power	2 x Rocker Switches
LEDs	
KVM Ports	16 (Green)
Power	2 (Green)
Panel Spec	
Size	1.6"
Resolution	128x64
Pushbuttons	
Select	3 x Pushbuttons (Up, Down, Enter)
Emulation	
Keyboard / Mouse	USB
Video	
Remote	Up to 3840 x 2160 @ 30Hz
Maximum Input Power Rating	100-240V~, 2.5A max, 50-60Hz
Power Consumption	AC110V:34.1W:117BTU/h AC220V:34.6W:118BTU/h  Note: ● The measurement in Watts indicates the typical power consumption of the device with no external loading. ● The measurement in BTU/h indicates the power consumption of the device when it is fully loaded.
Environmental	
Operating Temperature	0 - 40°C
Storage Temperature	-20 - 60°C
Humidity	10 - 80% RH, Non-condensing
Physical Properties	
Housing	Metal
Weight	5.86 kg ( 12.92 lb )
Dimensions (L x W x H)	43.36 x 37.90 x 4.40 cm (17.07 x 14.92 x 1.73 in.)
Note	Fiber or copper SFP modules are sold separately. Please find them on the compatible accessories list and order with KG devices together.
Note	For some of rack mount products, please note that the standard physical dimensions of WxDxH are expressed using a LxWxH format.

Diagram

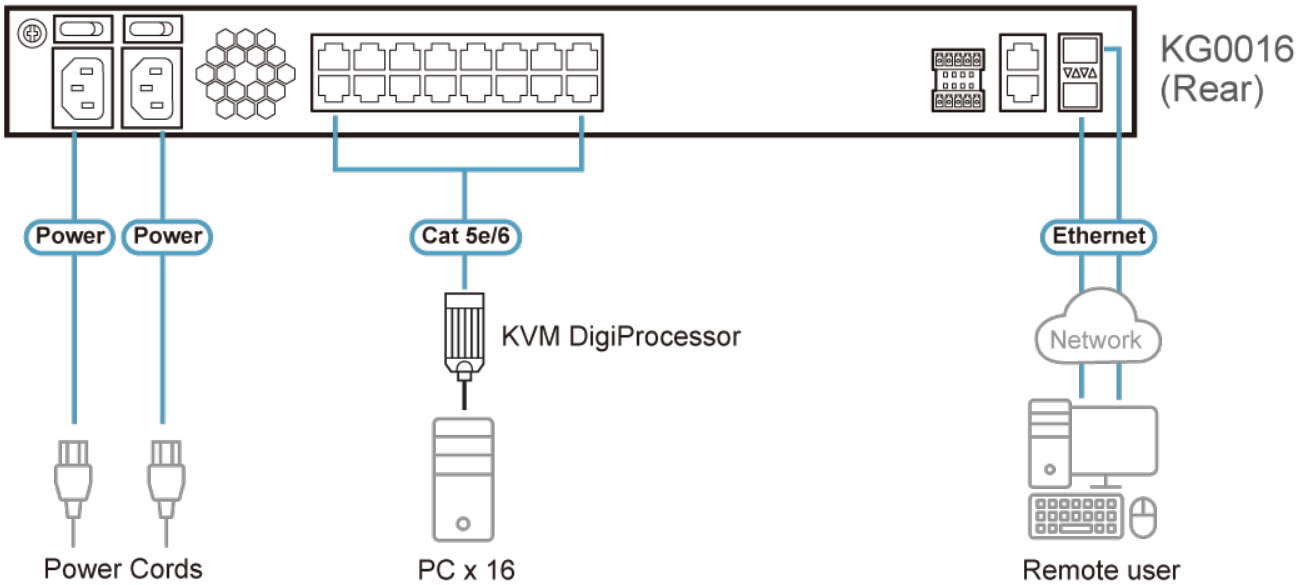
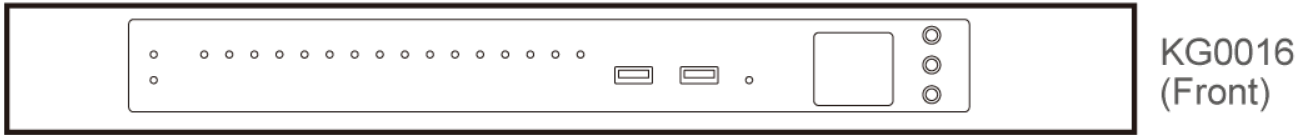

**ATEN International Co., Ltd.**

3F., No.125, Sec. 2, Datong Rd., Sijhih District., New Taipei City 221, Taiwan  
 Phone: 886-2-8692-6789 Fax: 886-2-8692-6767  
 www.aten.com E-mail: marketing@aten.com



© Copyright 2015 ATEN® International Co., Ltd.  
 ATEN and the ATEN logo are trademarks of ATEN International Co., Ltd.  
 All rights reserved. All other trademarks are the property of their respective owners.