

## VE8662

True 4K HDMI H.265 over IP Transceiver with PoE



VE8662 as Transmitter



VE8662 as Receiver

**ATEN**  
Simply Better Connections

# Delivering H.265 AV over IP Efficiency

## Stay on Target with True 4K Clarity

Extending the vision, capturing every moment on the field!

We're connecting more than visuals; we're connecting the spirit of the team!

Bringing every play's excitement to every corner

Bringing the gap with our products

**GOOD DESIGN AWARD 2024**

**4K TRUE**

**VE8662**  
True 4K HDMI H.265 Transceiver

LEADER		CHALLENGER		SATURDAY		CHAMPION TEAM	
AT	BAT	BALL	STRIKE	OUT	TOTAL		
53	0	0	0	1	2		
275	AUG	10	HR	60	RBI		
2	53	13	25	20	24	14	28
SS	RF	3B	DH	C	2B	1B	CF
LF							

The VE8662 True 4K HDMI H.265 over IP Transceiver with PoE sets a new standard for AV transmission, combining unparalleled efficiency with crystal-clear clarity. The transceiver, functioning as either a transmitter or receiver, enables flexible AV-over-IP expansion from a simple point-to-point setup to hundreds of endpoints. Powered by H.265 video compression, the VE8662 delivers ultra-clear True 4K visuals (4K60 4:4:4, HDCP 2.2) while requiring just 100 Mbps bandwidth, ensuring stable, low-latency streaming of video, audio, and control signals over standard networks. Quickly switch between multiple sources and displays with intuitive real-time control, offering instant visual feedback for both vertical and horizontal video walls. Designed for scalable AV setups, the VE8662 perfectly fits into the ATEN Networked AV solution, expanding coverage for various digital signage scenarios, including but not limited to sports venues, transportation hubs, and also control rooms where AV content can be efficiently shared and managed across workstations and video walls for real-time distribution.



Video & Audio Transceiver



Video Clarity

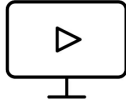

Video Streaming



On-Screen Display

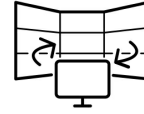

Video Wall Collaboration

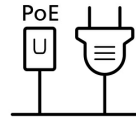

PoE & DC Power Redundancy

Streamlined Transceiver Setup in Seconds

The VE8662 ensures effortless setup and is easily configurable as a transmitter for video sources or a receiver for displays. Simply assign an ID number instead of complex IP settings for fast, hassle-free installation.

## Dual-Mode Configuration

Transmitter

ONLINE

T001

IP 255.255.255.255

Press 3s Unlock

True 4K HDMI H.265 over IP Transceiver with PoE  
VE8662

Receiver

ONLINE

R0001

IP 255.255.255.255

Channel [1999]

HDMI Out Stable

Press 3s Unlock

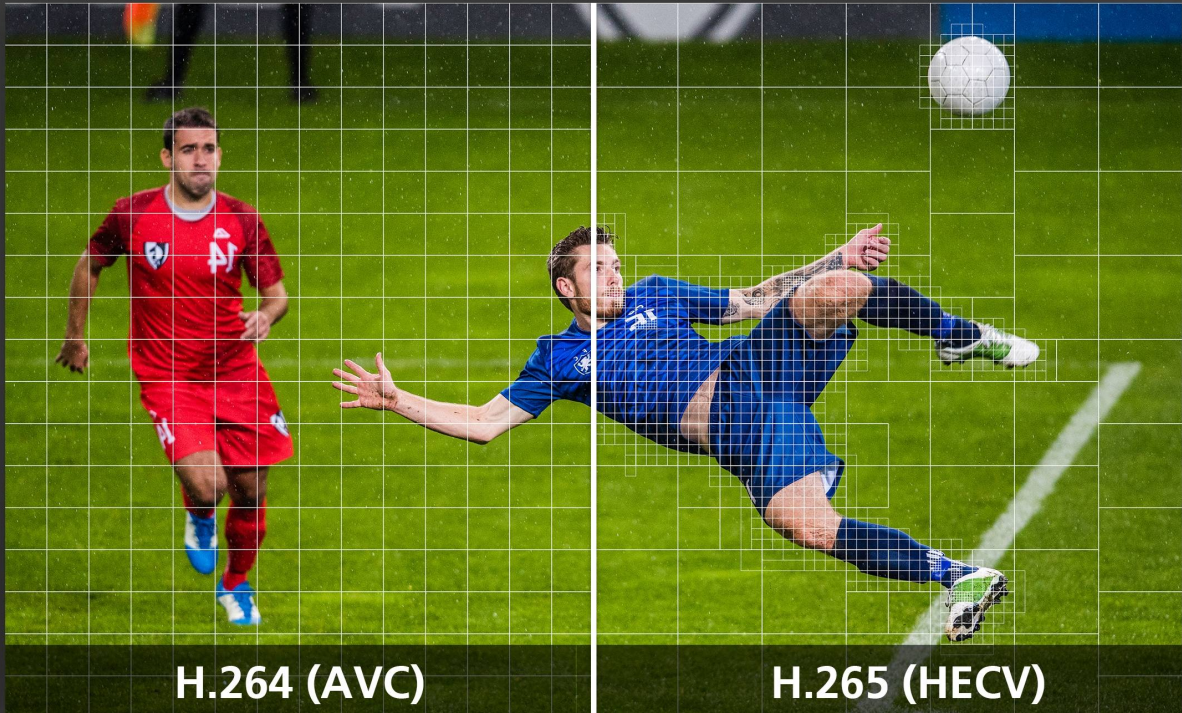

**Optimized AV Transmission with H.265 Efficiency**

The VE8662 employs the H.265 video compression standard with better compression efficiency that preserves quality while minimizing bandwidth usage, latency and signal loss, delivering sharper, more refined high-definition visuals than H.264.

**Audio Embedding/De-Embedding for Flexible AV Configurations**

By embedding audio directly into the HDMI signal, both audio and video are consolidated into a single connection, streamlining setup. When needed, the audio can also be de-embedded, separating it from the video stream to ensure compatibility with various audio systems.

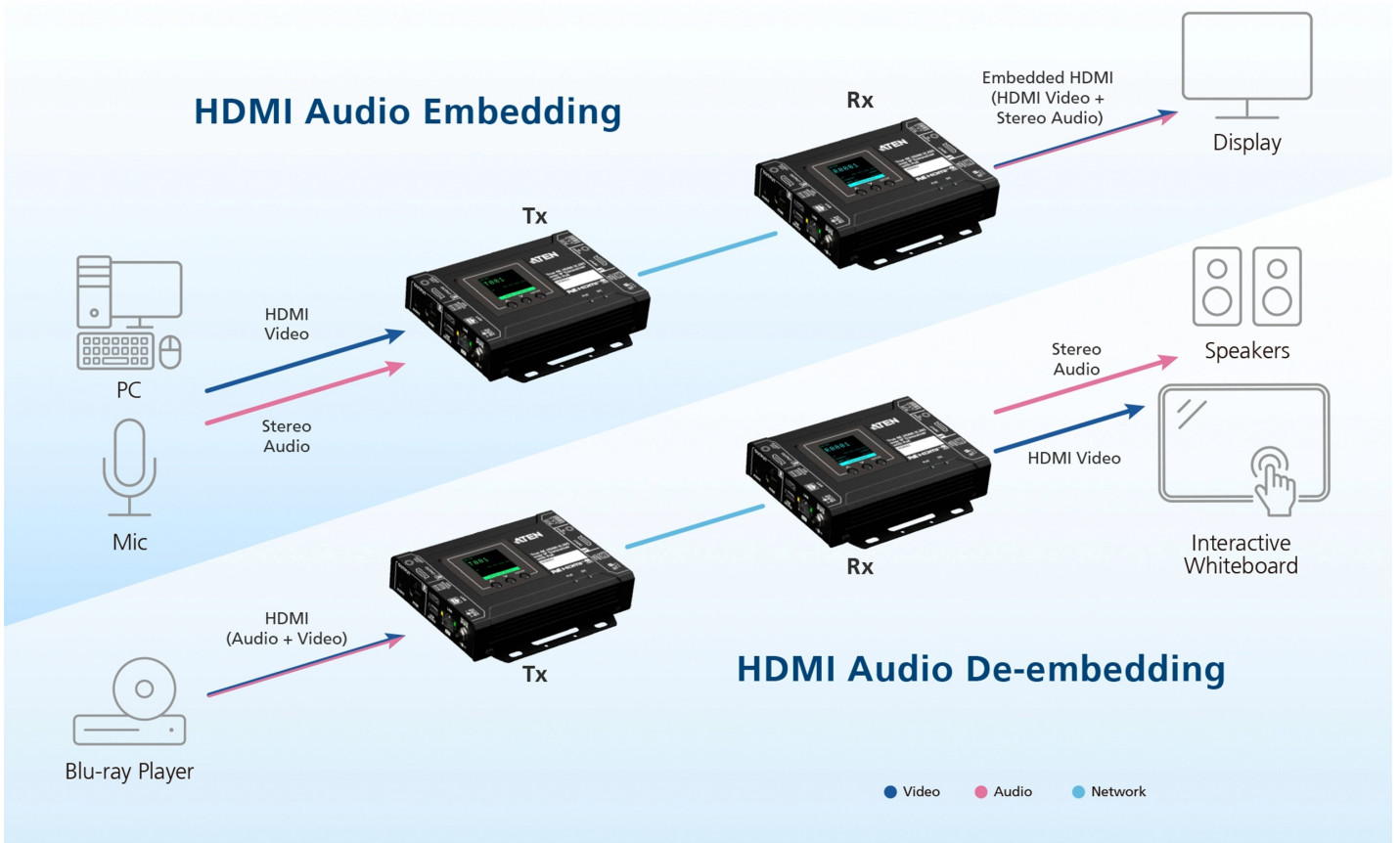

**Intuitive Web GUI Management with Customizable Layout**

Managing the VE8662 is simple with its user-friendly Web GUI. Video from each source and display can be easily dragged and dropped into a customizable background or layout for better management, enabling quick switching between video sources and displays.



**Integrated Video Wall Control for Collaborative Workflows**

To enhance video distribution and optimize collaboration, video content can be flexibly pushed or pulled between operators and a video wall using KVM control with an On-Screen Display (OSD) menu, enabling intuitive source selection and video feed management. Additionally, Boundless Switching allows effortless switching between video sources simply by moving the mouse cursor across screens, enhancing real-time situational awareness and informed decision-making.



**Dual Power Redundancy for Uninterrupted AV Excellence**

Engineered for maximum stability, the VE8662's PoE (Power over Ethernet) and DC power redundancy ensures consistent uptime and reliable AV performance from unexpected power failures.



**Scalable AV over IP Network Setup**

The VE8662 provides a scalable AV over IP solution that integrates effortlessly into a local area network, supporting multicast streaming and scalable cascading. This ensures flexibility and convenience for dynamic AV setups at any time.

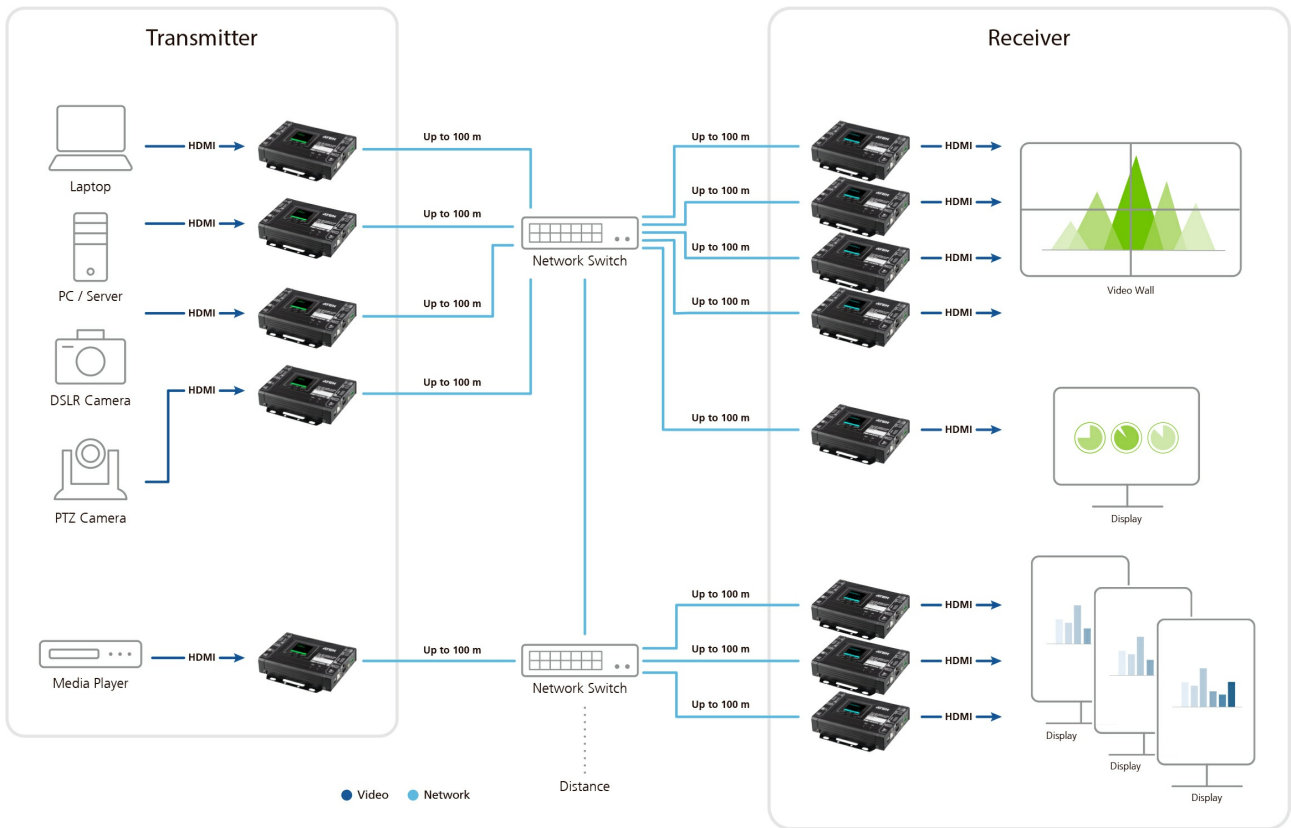

**Applications**

The VE8662 is ideal for digital signage scenarios, including sports venues, transportation hubs, and also control rooms, where AV content can be effectively managed and efficiently distributed within any networked AV setup.

- 1.
- 2.
- 3.
- 4.



Transportation Hub



Sports Venue

[Previous](#) [Next](#)

[Talk to Our Experts](#)

If you prefer to have ATEN contact you, please complete the form and a representative will be in touch with you shortly

First Name \*

Last Name \*

- Country \*

Company \*

Email \*

Phone Number \*

- Customer Type \*

Job Title \*



AV Transceiver

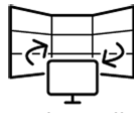

Video Wall Control

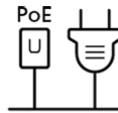

Redundancy



On-Screen Display

**Features**

The ATEN VE8662 True 4K HDMI H.265 over IP Transceiver with PoE combines transmitter and receiver functions in one unit, offering flexible deployment and easy configuration for various AV solutions.

Powered by standard H.265 encoding and decoding technology for video compression, the VE8662 enables efficient transmission of 3840 x 2160 @ 60 Hz (4:4:4) HDMI video / audio, stereo audio, USB 2.0, and RS-232 signals over a single Ethernet cable for up to 100 meters (point-to-point), with built-in error correction for low latency and reduced bandwidth usage. It also supports embedded and de-embedded audio, allowing audio to be embedded in the HDMI stream or extracted and delivered separately.

The VE8662 also features AV matrix switching with both horizontal and vertical display configurations for video walls. The Transceiver enables seamless collaboration between workstations and video walls with functions such as "push" and "pull" for instant content sharing, boundless switching for easy switching between receivers, and On-Screen Display (OSD) for simple configuration of both units.

With dual power supplies, DC-in, and Power over Ethernet (PoE), the VE8662 ensures continuous operation, even during power failures, making it ideal for mission-critical applications. The transceiver offers multiple control options, including pushbuttons, web GUI, RS-232 and Telnet / Reslink. The user-friendly web GUI enables customizable background and layouts for intuitive management over all video inputs and outputs.

With limitless scalability and flexibility, the VE8662 is perfect for diverse scenarios such as video broadcasting, casinos, sports centers, and smart buildings where managing multiple video feeds over a network is essential and can transmit signals from building to building.

**Advanced H.265 Compression with Low Latency**

- Extends True 4K HDMI signals over IP with H.265 compression for low latency and improved bandwidth efficiency
- Delivers visually lossless high-quality video up to 3840 x 2160 @ 60 Hz (4:4:4)
- EDID Expert™ selects the optimum EDID settings for smooth power-up, high-quality display and the best video resolution across different screens
- Supports HDR 10 with HDCP 2.3/2.2 compliant for content protection
- Supports individual stereo audio and HDMI audio format of PCM 2 channels
- Supports either PoE or DC-in; power redundancy when both are connected

**Limitless Scalability and Flexibility**

- Extends AV connections from a simple point-to-point to a multi-point to multi-point setup via up to 100 meters (point to point)
- Offers multiple functions for applications such as extenders, splitters, video walls, and matrix switches
- Built-in 8KV/15KV ESD protection
- Rack-mountable

**Collaboration with ATEN Control System**

- Integrated solution – compatible with ATEN Control System, allowing users to directly operate VE8662 via CLI Telnet, or RS-232 protocol
- Effortless operation – one click to effectively operate VE Manager, TV, projector, source player, and related equipments via touch panel and keypad

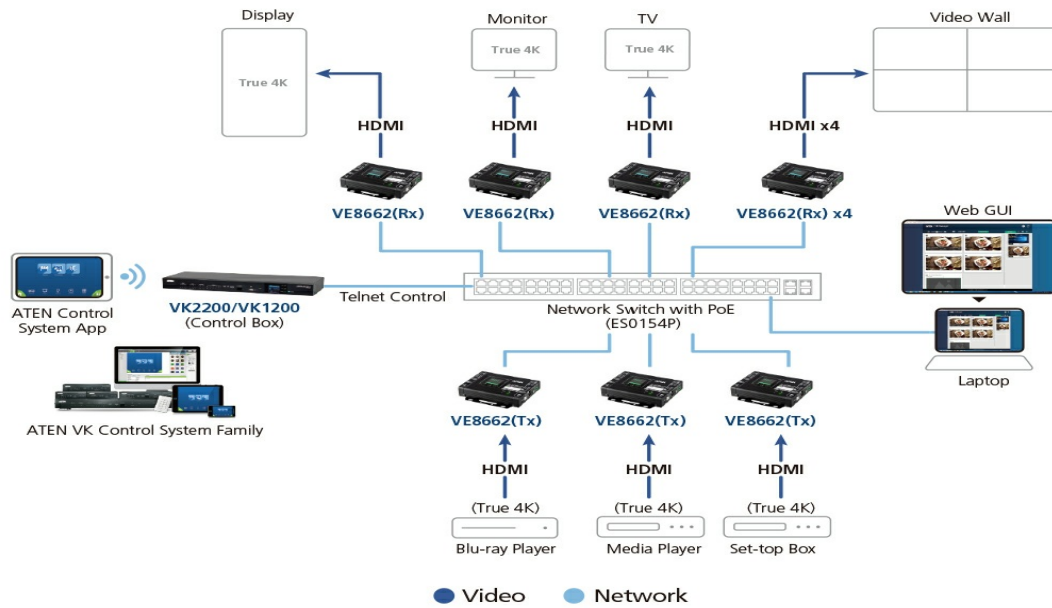

Note: VE8662 supports PoE and can be installed in combination with PoE network switches to reduce power cabling and additional power outlets. Before choosing the Network switch and installation, please refer to the Implementation Guide.

• **No Complicated IP Setup**

- Simple configuration with no extensive IT experience or extra learning required
- Assign ID numbers for fast installation, no complex IP settings required
- Single DIP switch enables easy switching between transmitter / receiver, with 'T' or 'R' shown on the LCM and distinct backlighting for easy identification



• Effortless source switching via pushbuttons

• **Web GUI-Based Management, No Additional Server PCs or Software Required**

- Drag-and-drop video sources, preview sources, and monitor displays via intuitive web GUI
- Contextualized web GUI with environmental pictures for intuitive control
- Fast switching enables real-time video streams and stable signal transmission
- User authority control for high-security applications

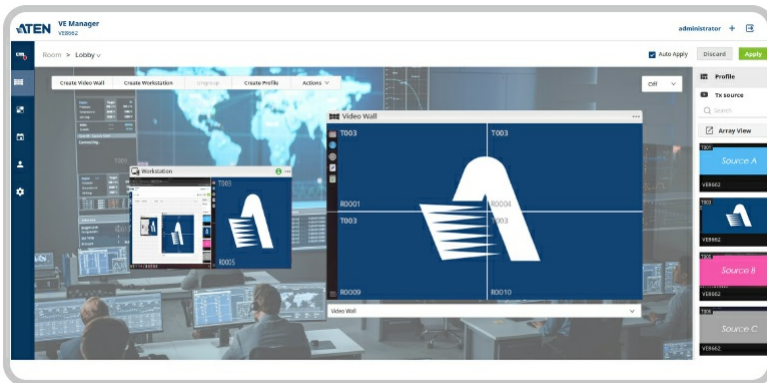

#### • Video Wall Support

- Real-time video display with "What You See Is What You Get" functionality
- Supports horizontal and vertical display orientations (including 90° and 270° rotations)
- "Push" and "Pull" – shares content instantly to / from a single Rx or video wall by just one click

#### • Spontaneous Scheduling Management

- User-friendly scheduling management with minute-level event control
- Group VE8662 devices by receivers or video walls for content editing and playback
- Multiple profiles arranged to play in any order over a selected time period

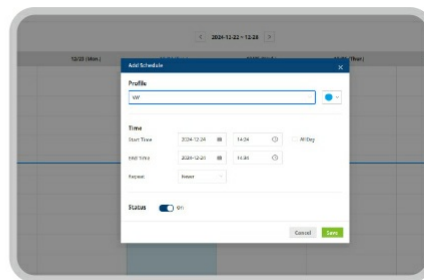
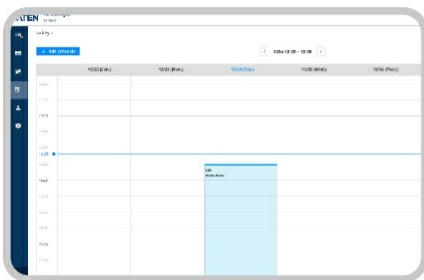

#### • Embedded / De-embedded Audio Support

- Separates audio signal can be embedded into the HDMI stream
- Audio stream can be extracted from the HDMI stream and delivered as a separate audio signal
- Supports Audio Matrix – routes audio from selected transmitters to selected receivers, allowing flexible setup based on different unit requirements

#### • Multiple Control Channels

- LCD screen – top-panel LCD screen and pushbuttons allow for switching input, monitoring the ID & IP address and status of the extender
- Intuitive web GUI – software independent, simple to operate it on any PC or Notebook
- USB Connectivity – USB 2.0 ports allow for connection of devices such as keyboard, mouse and USB touch panels
- RS-232 Channel – bi-directional RS-232 serial port allows for connection of peripherals such as touch screens and barcode scanners
- Supports Telnet / CLI, and SSH for remote control, management, and authorized security bypass
- Remote KVM control – hotkey switching (double-click the Ctrl key), OSD switching on the receiver, and boundless mouse switching

#### • High-Security Protection

- Supports dynamic UDP media multicast ports
- AES-128 encryption for AV streaming in SRTP (Secure Real-time Transport Protocol)
- HTTPS for secure communication
- WSS for encrypted real-time data communication

Note: If you experience issues related to your network architecture, please refer to the ATEN HDMI over IP Video Extender System Implementation Guide or contact ATEN representatives for assistance.



**Specification**

Video Input	
Max. Distance	5m
Impedance	100 Ω
Interfaces	1 x HDMI Type A Female (Black)
Video Output	
Interfaces	1 x HDMI Type A Female (Black)
Impedance	100 Ω
Max. Distance	5m
Video	
Max. Data Rate	Average: 20 ~ 25Mbps
Compliance	HDMI HDCP2.3 & HDCP2.2 Compatible
Max. Resolutions / Distance	Up to True 4K@100m (Cat 5e/6, point to point)  *True 4K supported: 3840 x 2160 @ 60Hz (4:4:4) only
Video Compression	H.265 Codec Latency: 3-5 frames
Audio	
Input	1 x HDMI Type A Female (Black) 1 x Mini Stereo Jack Female (Green)
Output	1 x HDMI Type A Female (Black) 1 x Mini Stereo Jack Female (Green)
Connectors	
Unit To Unit	1 x RJ-45 Female ( with POE)
Power	1 x DC Jack (Black) with locking or 1 x RJ-45 POE PD (Power Over Ethernet, Powered Device) port
Control	
RS-232	Connector: 1 x Terminal Block, 3 pole Baud Rate: 115200 (max.), Data Bits:8, Stop Bits:1, no parity and flow control
USB Channel	1 x USB Type B Female (Host) 2 x USB Type A Female (Device)
Pushbuttons	
Operating Mode Selection	3 x Push buttons for LCM operation
Switches	
Selection Mode	1 x Slide Switch - T (Be a Transmitter) / R (Be a Receiver) selection
LEDs	
Power	1 x DC IN LED (Green) 1 x POE LED (Green)
Power Consumption	DC12V:4.79W:22BTU/h (Tx) DC12V:4.98W:45BTU/h (Rx)  Note: ● The measurement in Watts indicates the typical power consumption of the device with no external loading. ● The measurement in BTU/h indicates the power consumption of the device when it is fully loaded.
Power	
Power over Ethernet (PoE)	IEEE 802.af POE compliant 5.99W:28BTU/h (Tx) 6.23W:51BTU/h (Rx)
Environmental	
Operating Temperature	0 - 40°C
Storage Temperature	-20 - 60°C

Humidity	0 - 80% RH, Non-Condensing
Physical Properties	
Housing	Metal
Weight	0.51 kg ( 1.12 lb )
Dimensions (L x W x H) with bracket	14.02 x 12.30 x 3.00 cm (5.52 x 4.84 x 1.18 in.)
Dimensions (L x W x H) without bracket	13.60 x 10.10 x 2.90 cm (5.35 x 3.98 x 1.14 in.)

Diagram

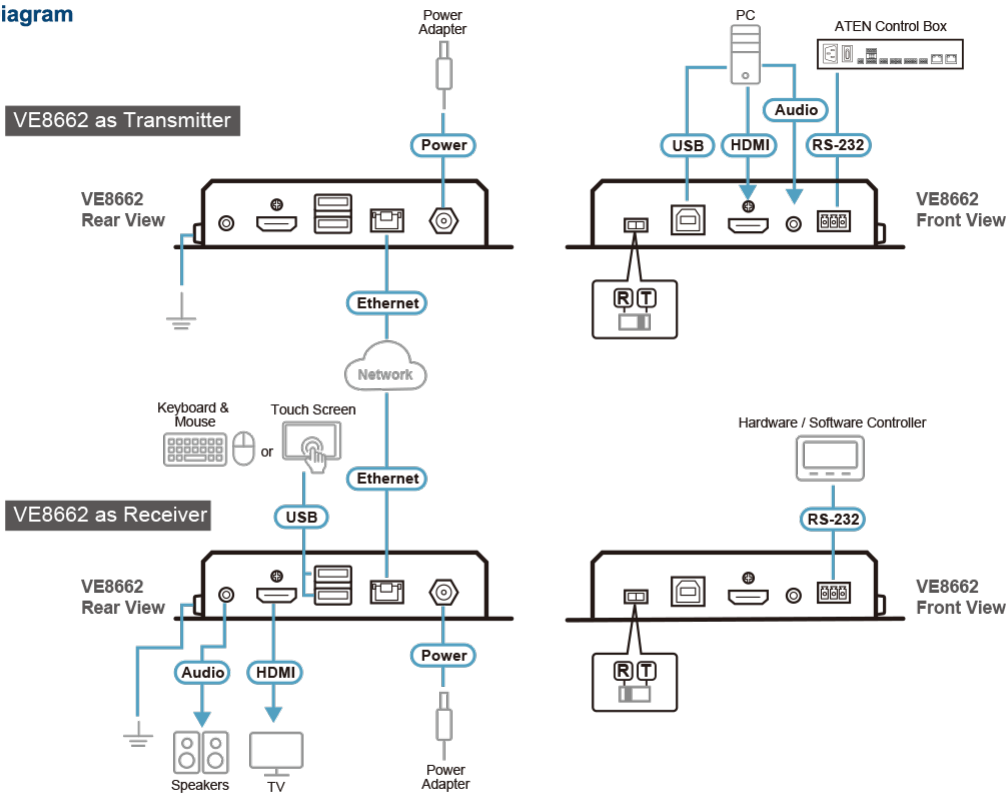
► Diagram



Note: The illustrated diagram is based on two VE8662 units.

**ATEN International Co., Ltd.**

3F., No.125, Sec. 2, Datong Rd., Sijhih District., New Taipei City 221, Taiwan  
 Phone: 886-2-8692-6789 Fax: 886-2-8692-6767  
 www.aten.com E-mail: marketing@aten.com



© Copyright 2015 ATEN® International Co., Ltd.  
 ATEN and the ATEN logo are trademarks of ATEN International Co., Ltd.  
 All rights reserved. All other trademarks are the property of their respective owners.