

VP2021

4K Wireless Presentation Switch with Quad View



Start Multi-party Collaboration Instantly with Wireless Sharing

PresentON[®]
VP2021 4K Wireless Presentation Switch with Quad View

Browser Sharing PC software Control with Mobile app; compatible with **Airplay[®]**, and **Google Cast[®]**

ATEN PresentON™ VP2021 is a wireless BYOD solution that enables anyone, including visitors, to easily share content from a laptop or mobile device so that participants can actively collaborate for enhanced, efficient workflows.

The VP2021 features Multi-view and audio out, which are designed to increase content-sharing flexibility. Moreover, it is equipped with USB touch back and moderation mode functions, allowing presenters to easily control meetings. The VP2021 also has innovative collaboration tools that allow teams to enhance their productivity. This solution also features remote view for all participants to immerse themselves in the presentation. In addition, its PoE connectivity makes installation easy. It's perfectly suited for both huddle spaces and large meeting spaces and is flexible enough for corporate or education use.

*The information contained is the property of ATEN International Co. LTD or their respective owners. All rights reserved. AirPlay® is a trademark of Apple Inc., registered in the U.S. and other countries and regions. Google Cast™ is a trademark of Google LLC. Any other brand names or marks are used for compatibility description only and are trademarks or registered trademarks of their respective owners.

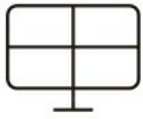

Multi-view Function

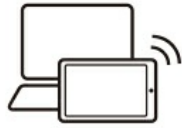

BYOD Wireless Sharing



USB Touch Back



Moderation Mode

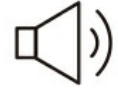

Audio Out



Collaboration Tools

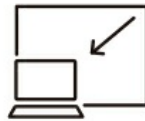

Remote View

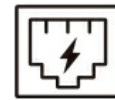

Power over Ethernet



Start Quad-view Sharing in a Snap

Quad view presentations make it feasible for cross-departmental collaboration to rapidly focus on key points and cross-reference information for discussion, helping to improve workflows and efficiency.

BYOD Wireless Sharing without Limitations

Wirelessly share BYOD presentation content with ATEN software on PC, mobile apps, and web browsers; compatible with Airplay* and Google Cast* for unlimited sharing and collaboration.

Browser Sharing
Start

Browser Sharing
Start

It's easy to start sharing!

Get Control on Your Side with USB Touch Back

USB Touch Back can control remote laptops with a mouse or touchscreen, allowing the speaker to take the lead in meetings and be more efficient without having to move about just to access devices.



Manage Shared Content with Moderation Mode

Moderation Mode allows presenters to easily control and manage the content shared by other participants, including muting, stopping all sharing, and disconnecting a participant.



Touch Back

Remote View

Moderation Mode

User List Stop All

× Susan

× Abby

× Mark

× Jonny

× David

Connection : 4 Remote View : 3



Flexible & Clear: Audio Your Way

With 3.5 mm audio output to increase the flexibility of use, not only is meeting audio crystal clear, but also it can be integrated with the audio system to enhance the audio-visual experience.

Bringing People Together to Share Ideas

Collaboration tools allow team discussions to illustrate ideas directly on the main screen, annotate, or quickly screen capture for record-keeping to enhance team productivity.



Contact Us

Get a quote for this product or get in touch with our sales experts

[Get Quote](#)

[Contact Sales](#)

Get More from Getting Involved

Remote View on the ATEN Presentation App lets remote participants view presentations from their own screens, save or copy the main screen, allowing them to be more immersed in the presentation.





Faster, Easier Setup means Less Hassle

With PoE, only one network cable is needed for power and information transmission, eliminating complicated wiring and offering flexibility in space deployment and speedy installation.

Applications

- BYOD-oriented workplaces for quick discussion, brainstorming, and rapid sharing of presentations
- Work environments with a high prevalence of teamwork and cross-functional departmental collaboration
- Group discussions with a need to share presentations at the same time, such as problem-based learning (PBL) environments
- Academic research environments with a need to present different sources of information at the same time



Product Comparison

Talk to Our Experts

If you prefer to have ATEN contact you, please complete the form and a representative will be in touch with you shortly

- Country * ▼

- Customer Type * ▼

▲

▼



Features

As a wireless BYOD solution, the VP2021 is a 4K presentation switch featuring a Wi-Fi module and multiple access approaches for the essential connectivity that a successful meeting requires. It enables users to cast up to 4K content to 1 HDMI-enabled display and 1 VGA-enabled display at the same time via Wi-Fi from their laptops or mobile devices. Such wireless connectivity supports all major operating platforms, including Windows, macOS, and Android, through the dedicated ATEN Wireless Presentation Switch App. Moreover, the VP2021 is compatible with AirPlay¹, Google Cast¹, and Chrome.

The VP2021 contains various features that make it a perfect collaboration terminal. The VP2021 enables up to 8 attendees to join the meeting remotely through its wireless connection or up to 20 attendees via LAN connection in the same network environment. With the capability of displaying multiple sources simultaneously, content can be presented in full screen / side-by-side / quad view screen layouts. When auto layout projection is enabled, the layout can be switched automatically whenever a new signal is detected. The USB-C and USB Type-A ports feature touchback functionality, delivering seamless operation of a presentation directly from a connected touchscreen or mouse. Moderation Mode gives the moderator access to manage and control attendees' connection status as well as the AV content being displayed. Moreover, the VP2021 supports collaboration tools, such as annotation, whiteboard on screen, and screen capturing, to take video conferencing and digital learning experiences to the next level.

Additional highlights include the all-metal enclosure that gives the presentation switch a sleek look while guaranteeing durability. VP2021's support for Power over Ethernet (PoE) connectivity makes installation easier without the need for an extra power adapter. Integration with audio amplifiers or mixing systems is made easier thanks to the audio de-embedding functionality. The VP2021 is a perfect fit for achieving seamless teamwork in any wireless meeting.

- A BYOD presentation switch with wireless presentation capability
- Up to 4K content can be output to 1 HDMI-enabled display and 1 VGA-enabled display at the same time
- Allows native content sharing from users' laptop screens through the ATEN Wireless Presentation Switch App available on Windows, macOS, and Android
- Compatible with popular operating systems, including AirPlay¹, Google Cast¹, and Chrome, for wireless content sharing
- Multi-view presentation – up to four sources can be shared wirelessly in full screen / side-by-side / quad view layout
- Auto layout projection – presentation layout can be switched automatically whenever a new signal is detected
- Multiple simultaneous connections – enables up to 8 attendees to join the meeting remotely through its wireless connection and up to 20 attendees via LAN connection in the same network environment
- Moderation Mode – the moderator can manage and control team members' connection status and the AV content being displayed
- Multiple collaboration tools – annotation, whiteboard on screen, and screen capturing
- USB touch back – allows for seamless operation of a presentation directly from a connected touchscreen or mouse
- Web GUI for control and configuration of the presentation switch
- Supports Power over Ethernet (PoE) connectivity for easier installation, eliminating the need for an additional power adapter
- HDMI audio de-embedding – enables easy integration with audio amplifiers or mixing systems
- A perfect collaboration terminal that suits any wireless video conference and digital learning application

*The information contained is the property of ATEN International Co. LTD or their respective owners. All rights reserved. AirPlay® is a trademark of Apple Inc., registered in the U.S. and other countries and regions. Google Cast™ is a trademark of Google LLC. Any other brand names or marks are used for compatibility description only and are trademarks or registered trademarks of their respective owners.

Specification

Video Output	
Interfaces	1 x HDMI Type A female (Black) 1 x VGA (HDB-15) Female
Max. Distance	HDMI: Up to 5m VGA: Up to 15m
Video	
Max. Resolution	HDMI: Up to 4K@30Hz VGA: Up to 1080p
Audio	
Output	Stereo Audio: 1 x mini stereo Jack female (Black)
Network Transfer Speed	10/100/1000 Mbps RJ 45 LAN (Support PoE)
Wireless	
Authentication Protocol	AP mode: WPA2-PSK Station mode: WEP, WPA, WPA2, 802.1x EAP
Wireless Transmission Protocol	IEEE 802.11ac
Frequency Band	Switchable dual band 2.4GHz and 5GHz (DFS channels not supported)
Reach	20m Transmission in 5GHz 30m Transmission in 2.4GHz
Connectors	
Console Ports	USB 3.0: 1 x USB Type A Female (Blue) USB 2.0: 1 x USB Type A Female USB-C: 1 x USB Type C Female
Power	1 x DC Jack (Black)
Switches	
Power	1 x Pushbutton (LED: Blue)
Control	
Ethernet	1 x RJ-45 Female (Silver)
Power Consumption	DC12V:12WBTU/h Note: ● The measurement in Watts indicates the typical power consumption of the device with no external loading. ● The measurement in BTU/h indicates the power consumption of the device when it is fully loaded.
Environmental	
Operating Temperature	0-40°C
Storage Temperature	-20 - 60°C
Humidity	0 - 80% RH, Non-Condensing
Physical Properties	
Housing	Metal
Weight	0.47 kg (1.04 lb)
Dimensions (L x W x H)	17.00 x 10.40 x 2.83 cm (6.69 x 4.09 x 1.11 in.)
Carton Lot	5 pc
Note	For some of rack mount products, please note that the standard physical dimensions of WxDxH are expressed using a LxWxH format.

Diagram

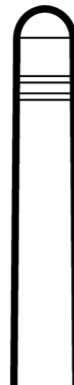

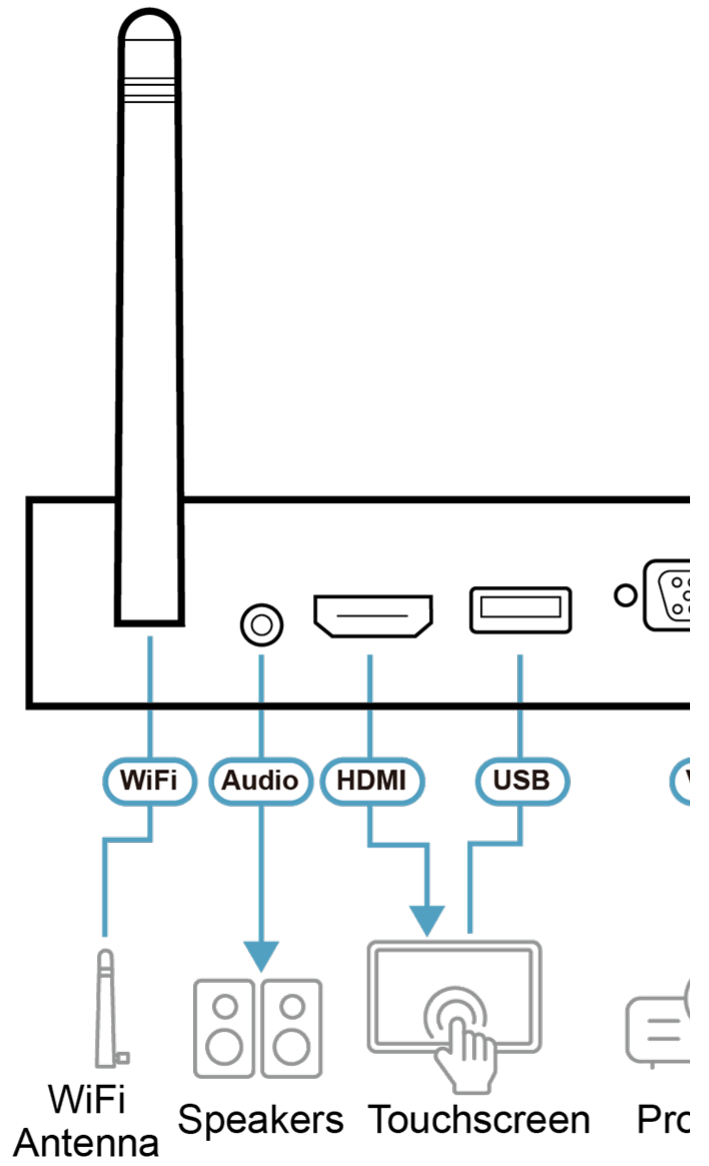
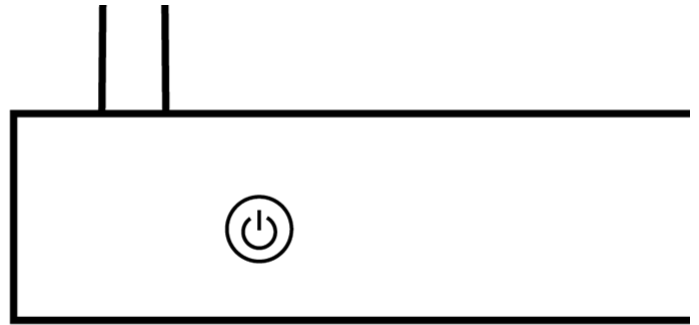



Simply Better Connections

ATEN International Co., Ltd.

3F., No.125, Sec. 2, Datong Rd., Sijhih District., New Taipei City 221, Taiwan
Phone: 886-2-8692-6789 Fax: 886-2-8692-6767
www.aten.com E-mail: marketing@aten.com



© Copyright 2015 ATEN® International Co., Ltd.
ATEN and the ATEN logo are trademarks of ATEN International Co., Ltd.
All rights reserved. All other trademarks are the property of their
respective owners.