

SN3002

2-Port RS-232 Secure Serial Device Server



[TEST NOW!](#)

An easy-to-use, secure, and reliable solution makes it easier to connect a wide range of serial devices to an IP-based Ethernet LAN in an instant. The ATEN SN3002 series of Secure Device Servers provide simple, fast serial-to-Ethernet connectivity, allowing users to remotely access serial RS-232 devices from a PC located anywhere. With various reliable features, the SN3002 solution is ideal for commercial and industrial process control applications.



Instantly Connect Serial Devices with Secure Access

SN3002 Secure Device Server



Serial-to-Ethernet



Surge Protection



1.5 kV Magnetic Isolation

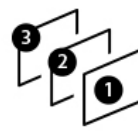

3-step Web Console



Power Redundancy

Surge and Isolation Protection Ensure System Stability

Surge protection is a vital aspect of any facility's coordinated electrical protection to ensure safe and reliable operation. To this end, in addition to 1.5kV magnetic isolation protection for Ethernet signals, the SN3002 series of Secure Device Servers feature surge protection for serial, Ethernet, and power that prevent an uncontrolled increase in voltage spikes or current. Furthermore, as well as industrial safety standards compliance, they are also tested to meet IEC 61000-4 surge wave form requirements to ensure system stability and reliability.

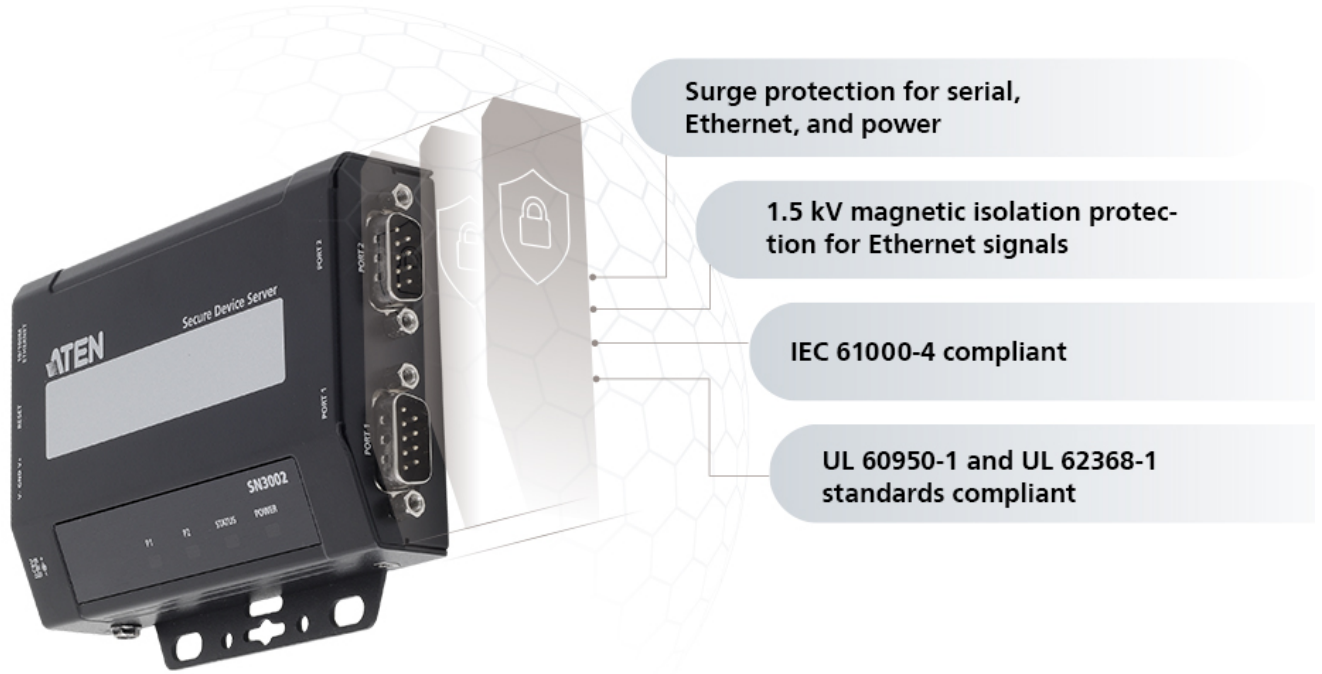

Level-up Device Security at Every Stage

The growing numbers of cyber attacks in the industrial IoT era has the potential to bring down systems and cause huge losses of time and money. In order to avoid potential vulnerability risks, enterprises need a multi-layered defense system to ensure secure data transmissions that include regular firmware upgrades, as well as various encrypted forms of authentication and access control. SN3002 secure serial-to-Ethernet solutions are equipped with security functions at every level, including network access control and user authentication, data integrity and confidentiality. Furthermore, with an operation mode available for advanced security functions, you can acquire any field data needed and provide frontline protection.

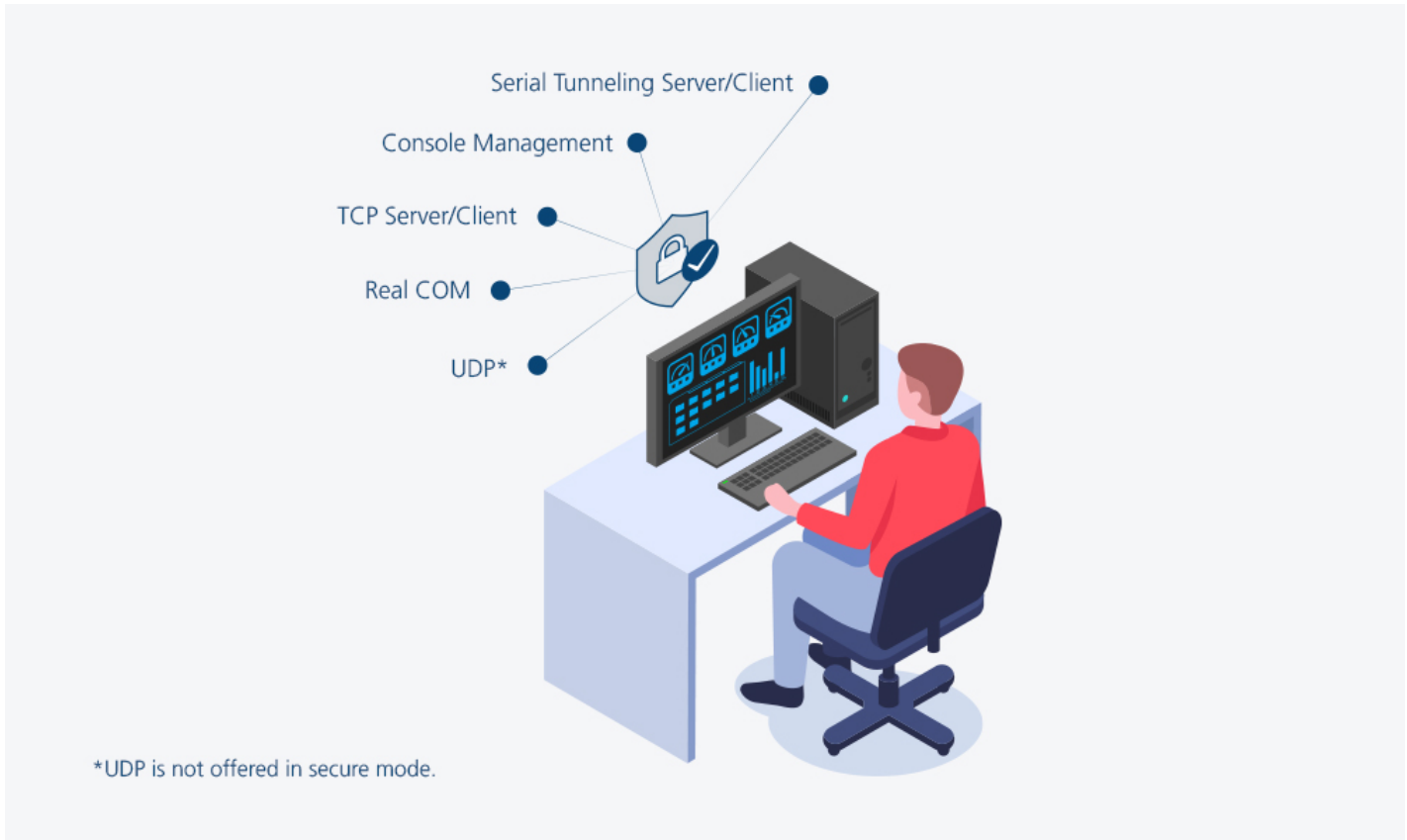
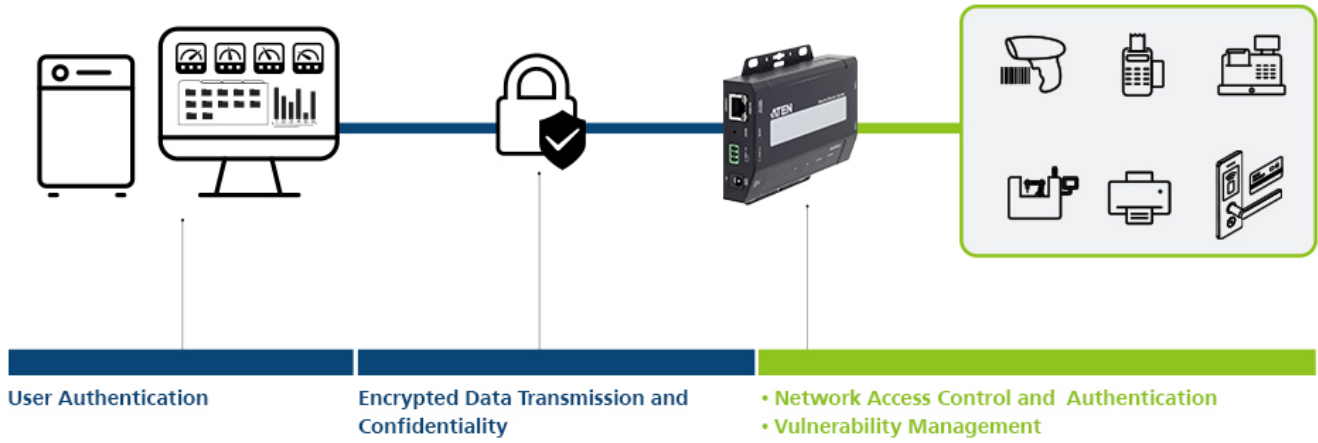

The SN3002 series offers a broad choice of operation modes to help different types of serial devices to be seen on the network including Real COM, TCP, Serial Tunneling, Console Management and UDP. With each operation mode SN3002 models are equipped with advanced secure functions to assist users in streamlining operations and ensuring serial data is securely transmitted.

*UDP is not offered in secure mode.

Easy Setup with Web Console and Telnet/SSH Console

The SN3002 series offers a 3-step setup web console for fast installation. Its browser access is supported via an intuitive multi-language features that facilitate a quick setup and control of the devices in just three configuration steps to activate the application. This makes the connection simple and fast, and users can complete it in an average of only one minute. Moreover, for bandwidth-sensitive applications, a Telnet/SSH console is also available as a low-bandwidth solution.



Intuitive web console for fast configuration



Terminal-based access via Telnet/SSH console for low-bandwidth applications



Ultra-Low Power Consumption

Operates in standby mode of less than 1W for power critical applications or cost saving.



Redundant Power

Ensures constant system availability and uptime in industrial environments.

Easy to Troubleshoot

ATEN understands the seriousness of data loss and breaches. The SN3002 series features 64 KB port buffering to prevent data loss in case a network is down, and event notifications will be sent automatically by SMTP email and SNMP Trap if serial devices go offline due to power failure, or trigger a user defined error. Moreover, system event logs are available to record and track operation history, and can be saved to internal memory or Syslog server, so you can retrieve data for monitoring and troubleshooting at any time.

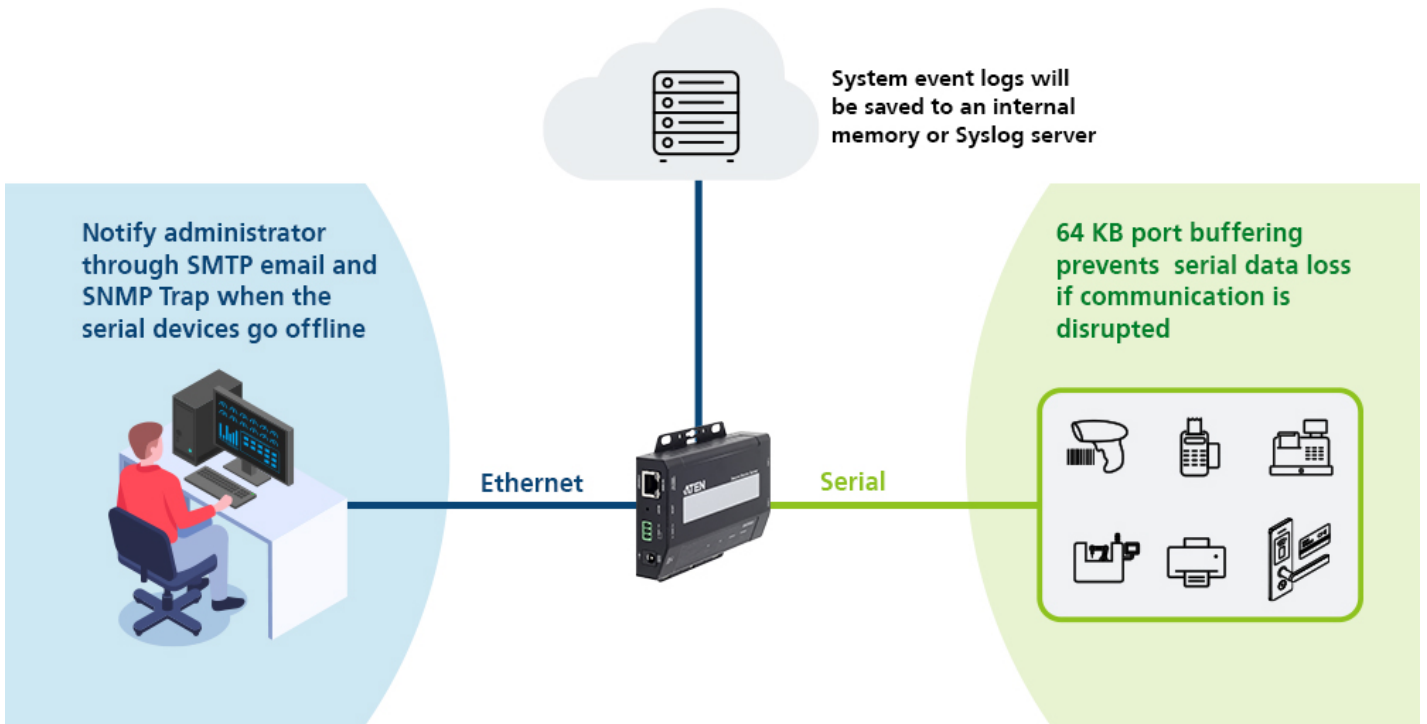

Target Applications

The SN3002 series enables instant networking of serial devices and can be deployed in a variety of commercial applications and industrial process automation environments that require serial-to-Ethernet connectivity. These include POS, access control, SCADA systems, environment monitoring, sensor monitoring, device management, remote site management, and more.

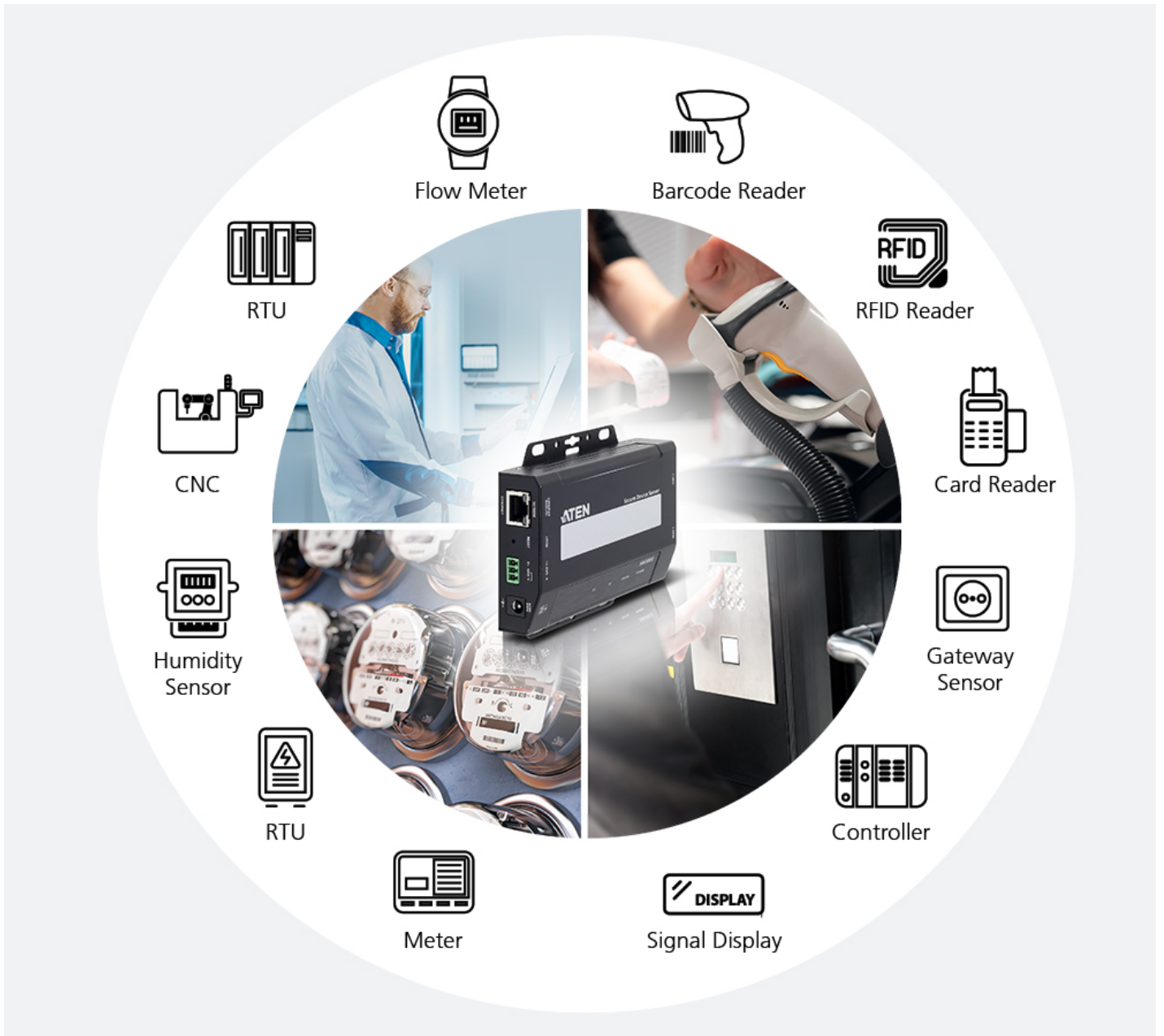

Versatile Mounting Options

The SN3002 series can be flexibly mounted in various installation environments, so you can easily configure them to your workplace. Mounting options include wall, desktop, DIN rail mounting, or rack mounting (with optional kit [VE-RMK1U](#)) as required.



Product Comparison

Features

ATEN SN3000 series Secure Serial Device Servers are external IP-based network devices that securely connect legacy serial RS-232 devices to an Ethernet network to be accessed remotely from a computer located anywhere, allowing you to expand the number of serial ports for any host computer over a network.

The SN3000 series is especially suited for industrial process control applications, given the abundant use of the Supervisory Control and Data Acquisition (SCADA) systems across many industries for collecting data from PLCs, meters, and sensors via serial ports. The SN3000 series bidirectionally translates data between serial and Ethernet formats, and facilitates access to the data from all data collection instruments from local and remote sites through an Ethernet network.

The SN3000 series has a number of useful operation modes. It supports Secure TCP Server / Client, Secure Serial Tunneling Server / Client, Secure Real COM, and console management modes for security-critical applications, such as telecom, access control, and remote site management.

• Serial-to-Ethernet Connectivity

- 2 RS-232 serial ports for secured serial data over Ethernet transmission
- Secured operation modes – Secure Real COM, Secure TCP Server / Client, Secure Serial Tunneling Server / Client, Console Management (SSH), and Console Management Direct (SSH)
- Standard operation modes – Real COM, TCP Server / Client, Serial Tunneling Server / Client, UDP, Console Management (Telnet), and Console Management Direct (Telnet)
- Real COM, Real TTY, and Fixed TTY drivers for Windows, Linux, and UNIX
- Convenient console management access via Java viewer (SSH/Telnet) or third-party clients such as PuTTY
- Easy console port access via Java viewer and Sun Solaris ready ("break-safe")
- Multiple users can simultaneously access the same port – up to 16 connections per port

• Hardware

- Redundant power input (power jack and terminal block) for fail-safe power
- Surge protection for serial, Ethernet, and power
- DIN-rail mounting, wall mounting, rack mounting, and desktop installation available
- Supports baud rates of 110, 134, 150, 300, 600, 1200, 1800, 2400, 4800, 7200, 9600, 19200, 38400, 57600, 115200, 230.4k, 460.8k, 921.6k bps

• Security

- Supports secured login from browsers with TLS 1.2 data encryption and RSA 2048-bit certificates
- Configurable user permissions for port access and control
- Local and remote authentication and login
- Third-party authentication (e.g. RADIUS)
- IP address filter for security protection

• System Management

- Browser access with an intuitive GUI design
- Web-based quick setup wizard for fast configuration
- Terminal-based access with a menu-driven UI via Telnet / SSH
- Online / Offline detection of connected serial devices (including terminal blocks) – automatically sending event notifications when the devices are offline (e.g. power failure) for device status monitoring
- System event logs will be saved to an internal memory or Syslog server
- Port logs will be saved to an internal memory or Syslog server
- SNMP agent (v1/v2c)
- Event notification – supports notification of SMTP email and SNMP Trap (v1/v2c)
- Backup / Restore system configuration and upgradeable firmware
- 64 KB port buffer prevents data loss when the network is down
- NTP for time server synchronization
- Multi-language web-based GUI

Specification

Connectors	
Serial	2 x DB-9 Male
Network	1 x RJ-45 Female
Power	1 x DC Jack 1 x 3-pole Terminal Block
Switches	
Reset	1 x Semi-recessed Pushbutton
LEDs	
Power	1 (Green)
Status	1 (Yellow Green/Red)
10/100 Mbps	2 (Green/Orange)
Ports	2 (Green/Orange)
Input voltage	DC Jack: 9VDC (Power Adapter: 9VDC , 100-240VAC 50~60 Hz) Terminal Block: 9-48 VDC
Power Consumption	DC9V:0.769W:4BTU/h DC48V:0.939W:4BTU/h Note: ● The measurement in Watts indicates the typical power consumption of the device with no external loading. ● The measurement in BTU/h indicates the power consumption of the device when it is fully loaded.
Interfaces	
Serial	RS-232: TxD, RxD, RTS, CTS, DTR, DSR, DCD, GND Baud Rate: 110, 134, 150, 300, 600, 1200, 1800, 2400, 4800, 7200, 9600, 19200, 38400, 57600, 115200, 230400, 460800, 921600 bps Data Bits: 5, 6, 7, 8 Parity: None, Even, Odd, Space, Mark Stop Bits: 1, 1.5, 2 Flow Control: RTS/CTS, DTR/DSR, XON/XOFF
Network	10/100 Base TX Built-in 1.5 kV Magnetic Isolation Protection
Compliance	EMC: EN 55032/35 EMI: CISPR 32, FCC Part 15B Class A EMS: IEC 61000-4-2 ESD: Contact: 4 kV; Air: 8 kV IEC 61000-4-3 RS: 80 MHz to 1 GHz: 3 V/m IEC 61000-4-4 EFT: Power: 1 kV; Signal: 0.5 kV IEC 61000-4-5 Surge: Power: 2 kV (Power Adapter), 1kV (Terminal Block); Signal: 1 kV IEC 61000-4-6 CS: 150 kHz to 10 MHz: 3 V/m; 10 kHz to 30 MHz: 3 to 1 V/m; 30 kHz to 80 MHz: 1 V/m IEC 61000-4-8 PFMF IEC 61000-4-11 DIPs Safety: UL 60950-1 and UL 62368-1 standards compliant RoHS
Environmental	
Operating Temperature	0 - 60°C
Storage Temperature	-40 - 75°C
Humidity	5 ~ 95% RH, Non-condensing
Physical Properties	
Housing	Metal
Weight	0.21 kg (0.46 lb)
Dimensions (L x W x H)	9.80 x 11.70 x 2.60 cm (3.86 x 4.61 x 1.02 in.)
Installation	Desktop, Wall Mounting, Din-Rail Mounting, Rack Mounting (with VE-RMK1U)
Others	Rack mounting kit (VE-RMK1U) is sold separately.
Note	For some of rack mount products, please note that the standard physical dimensions of WxDxH are expressed using a LxWxH format.

Diagram

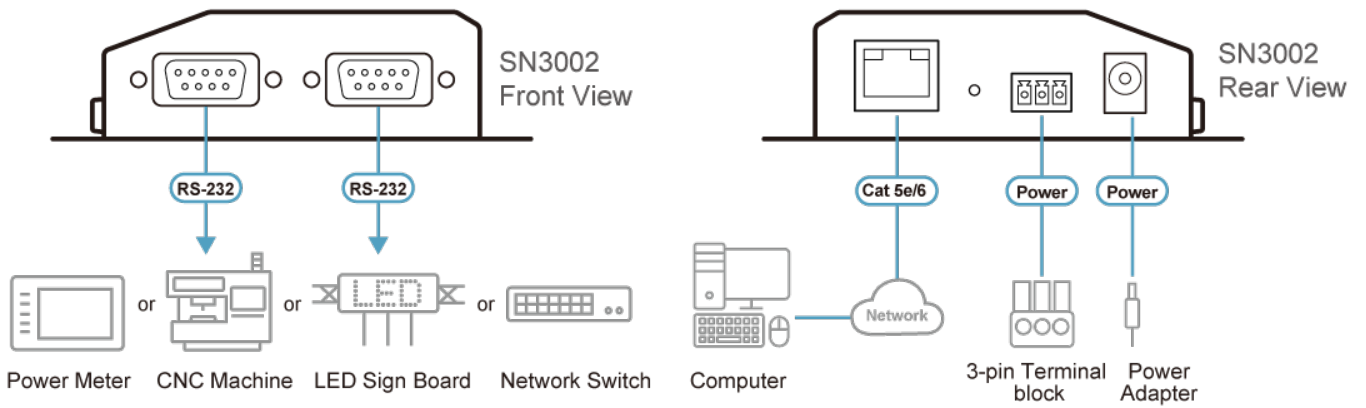

ATEN International Co., Ltd.

3F., No.125, Sec. 2, Datong Rd., Sijhih District., New Taipei City 221, Taiwan
 Phone: 886-2-8692-6789 Fax: 886-2-8692-6767
 www.aten.com E-mail: marketing@aten.com



© Copyright 2015 ATEN® International Co., Ltd.
 ATEN and the ATEN logo are trademarks of ATEN International Co., Ltd.
 All rights reserved. All other trademarks are the property of their respective owners.