

VS481C

4-Port True 4K HDMI Switch



Simplified Switching of 4 True 4K Sources



Nintendo Switch and related logos are registered trademarks of Nintendo of America, Inc. References to services and compatible products, such as those offered and produced by Nintendo are not intended to suggest any endorsement or sponsorship by or affiliation with product manufacturers.

VS481C

4-Port True 4K HDMI Switch

The VS481C is a 4-port video switch that enables fast switching between four HDMI sources, delivering up to True 4K audiovisual content to a single HDMI display. It's an ideal addition to any AV setup where multiple video feeds need to be shared and switched instantly – perfect for home entertainment systems, meeting rooms, retail displays, and more.

Instant Switching between 4 HDMI Inputs

Enjoy a variety of video content by switching between 4 HDMI source devices, such as computers, media players, and more.

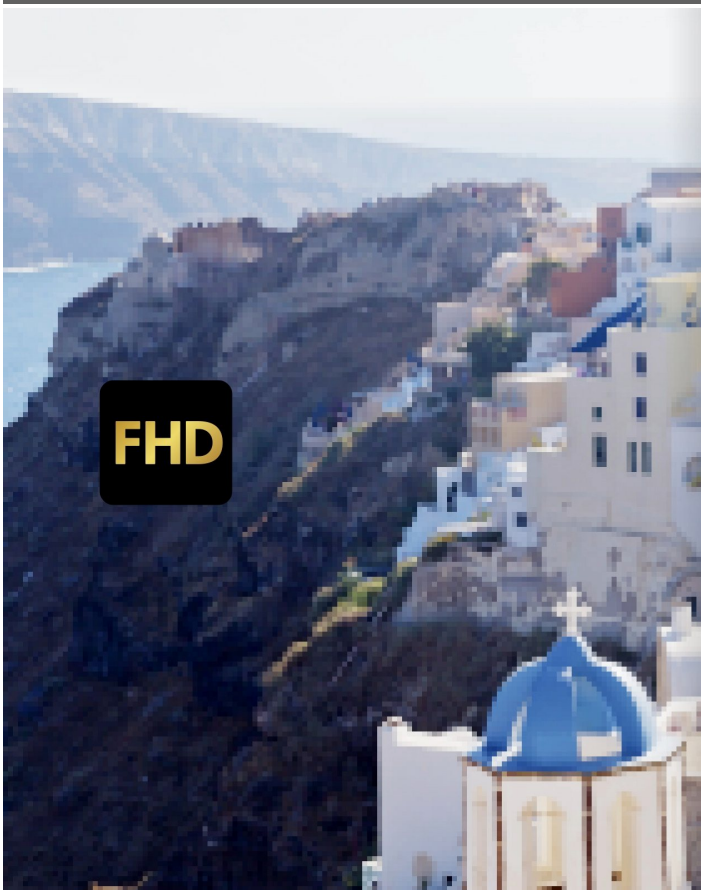
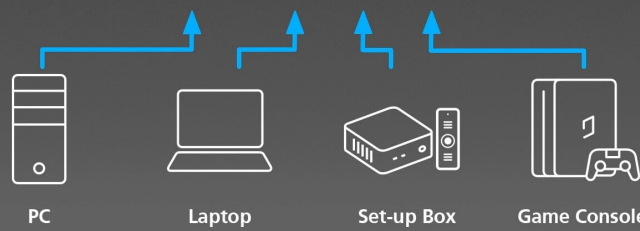
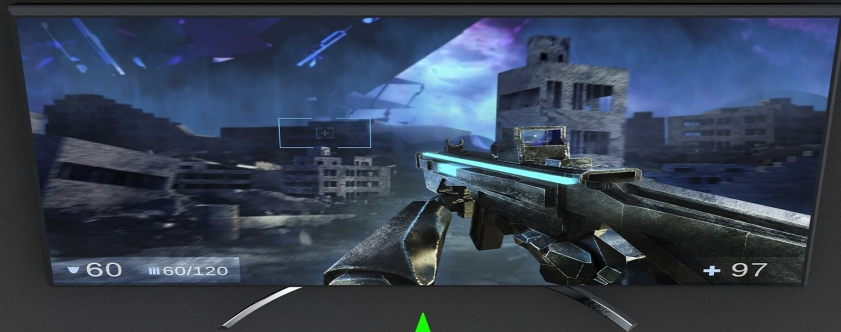

True 4K Visual Clarity

The VS481C delivers stunning video quality with crystal-clear detail at resolutions up to True 4K (4096×2160 / 3840×2160 @ 60Hz, 4:4:4).

Long-Distance 4K Transmission

The video switch supports flexible cabling with connections to each HDMI source and display of up to 5 meters ([2L-7D05H](#) recommended), delivering optimal 4K visual clarity (4096 × 2160 / 3840 × 2160 @ 30 Hz, 4:4:4) in any AV setup.



Flexible Switching Options

Switching is made easy with front-panel pushbuttons or the included IR remote control. Port selection can also be managed via a high-end controller, PC, or automation/theater software through an RS-232 serial connection to the switch. Or simply enable Auto Switch mode to automatically prioritize the most recently connected device as the video source.



▶ Pushbutton



Remote Control ▶



▶ RS-232 Control



Auto Switch ▶

Applications

The VS481C is well suited for any commercial or professional application requiring instant switching between multiple video sources for various viewing purposes.

- 1.
- 2.
- 3.
- 4.





Classroom



Meeting Room



Post Production

[Previous](#) [Next](#)

Commitment to Best Quality

Each product is rigorously tested under diverse environmental conditions to ensure high-quality, reliable, and cost-effective performance for our customers.



Temperature & Humidity Test



Reliability Test

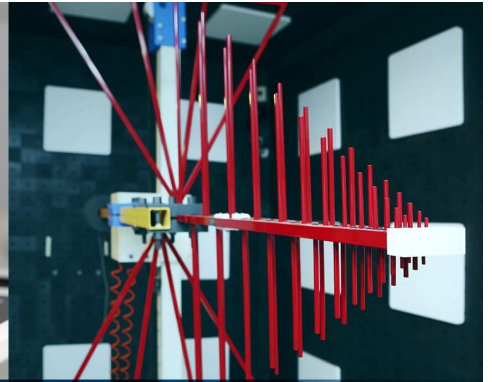

Electrical Safety Test



ISO9001:2015 & ISO14000

Talk to Our Experts

If you prefer to have ATEN contact you, please complete the form and a representative will be in touch with you shortly

First Name *

Last Name *

- Country *

Company *

Email *

Phone Number *

- Customer Type *

Job Title *



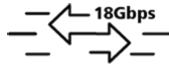

18Gbps Max. Bandwidth

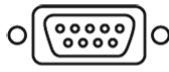

RS-232 Control



Flexible Switching



IR Remote Control

Features

The ATEN VS481C is designed for applications that require the routing of 4 sources to one compatible display device. It enables the reliable transmission at video resolutions up to True 4K (4096 x 2160 @ 60Hz 4:4:4), data rates up to 18 Gbps, 3D, Deep Color up to 12-bit, and HD lossless audio formats. Integrator-friendly features include Auto Switching modes for auto port selection, bi-directional RS-232, and IR for remote device control.

Engineered to meet today's demand of True 4K signal transmission and user-oriented design, the ATEN VS481C is a powerful solution for a wide range of settings, such as home theater, meeting rooms, trade shows, and shopping centers.

- Allows up to 4 HDMI sources to be connected to one HDMI display
- HDMI (3D, Deep Color, 4K); HDCP 2.2 compliant
- Superior video quality- True 4k resolutions of 4k x 2k @ 60 Hz (4:4:4)
- Supports HDR10+
- Supports IR extension
- Built-in bi-directional RS-232 serial port for high-end system control
- Auto switching modes for auto port selection
- LED indication of source device status
- Plug-and-play

Specifications

Switches	
DIP	Auto Switch ON/OFF
Video Input	
Interfaces	4 x HDMI Type A Female (Black)
Impedance	100 Ω
Max. Distance	5M at 4096 x 2160 / 3840 x 2160 @ 60Hz (4:4:4)
Video Output	
Interfaces	1 x HDMI Type A Female (Black)
Impedance	100 Ω
Max. Distance	5M at 4096 x 2160 / 3840 x 2160 @ 60Hz (4:4:4)
Video	
Max. Data Rate	18 Gbps (6 Gbps Per Lane)
Max. Pixel Clock	600 MHz
Compliance	HDMI (3D, Deep Color, 4K) HDCP 2.2 Consumer Electronics Control (CEC)
Max. Resolution	4096 x 2160 / 3840 x 2160 @ 60Hz (4:4:4)
Control	
RS-232	Connector : 1 x DB-9 Female (Black) Baud Rate : 19200 / Data Bits : 8 / Stop Bits : 1 / Parity : NO / Flow Control : NO
IR	1 x Mini Stereo Jack Female (Black) 1 x IR Receiver
Connectors	
Power	1 x DC Jack (with locking)
Power Consumption	DC5V:0.924W:20BTU/h Note: ● The measurement in Watts indicates the typical power consumption of the device with no external loading. ● The measurement in BTU/h indicates the power consumption of the device when it is fully loaded.
Environmental	
Operating Temperature	0-40 °C
Storage Temperature	-20 - 60 °C
Humidity	0 - 80% RH, Non-Condensing
Physical Properties	
Housing	Metal
Weight	0.47 kg (1.04 lb)
Dimensions (L x W x H)	20.00 x 8.21 x 2.50 cm (7.87 x 3.23 x 0.98 in.)
Carton Lot	10 pcs
Note	For some of rack mount products, please note that the standard physical dimensions of WxDxH are expressed using a LxWxH format.

Diagram

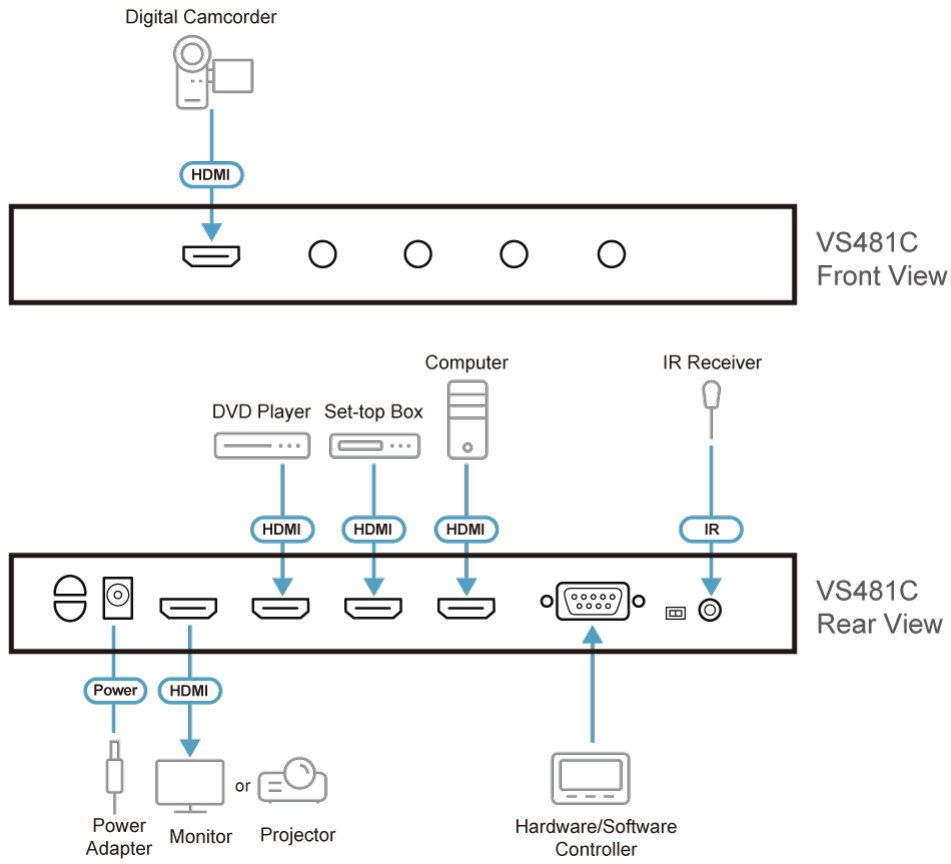

ATEN International Co., Ltd.

3F., No. 125, Sec. 2, Datong Rd., Sijhih District., New Taipei City 221, Taiwan
 Phone: 886-2-8692-6789 Fax: 886-2-8692-6767
 www.aten.com E-mail: marketing@aten.com



© Copyright 2015 ATEN® International Co., Ltd.
 ATEN and the ATEN logo are trademarks of ATEN International Co., Ltd.
 All rights reserved. All other trademarks are the property of their respective owners.