

VE8950T

4K HDMI over IP Transmitter



The ATEN VE8950T Video over IP Transmitter delivers visually lossless 4K AV signals with low latency over long distance via a local network of standard Gigabit network switch*.

The VE8950T provides an effective, easy-to-use, and economical digital signage solution with the following features and advantages that directly address the challenges system integrators encounter when implementing AV over IP systems:

- Limitless scalability and flexibility
- No complicated IP setup
- No additional server PCs or software required
- Go further for less with daisy chaining

Engineered to meet today's demands of large scale, multi-display, 4K signal transmission, and designed to be easy to set up and operate, the VE8950T Video over IP Transmitter is an ideal product for a wide range of environments, such as trade shows, airports, university campuses, conference centers, and shopping centers.

*Note: Regarding the detail information requirement of network switch, please refer to Implementation guide : https://assets.aten.com/product/manual/Implementation_Guide.pdf



Features

- **Lightweight Compression with Ultra-low Latency**
 - Delivers visually lossless high-quality video up to 4K @ 30 Hz 4:4:4
 - Ensures stunning quality video using ATEN advanced video lossless compression technology

- EDID Expert™ selects the optimum EDID settings for smooth power-up, high-quality display and the best video resolution across different screens
- Offers different levels of video compression rate including Smooth, Balance, and High Quality for users to choose depending on practical usage

• Limitless Scalability and Flexibility

- Extends AV connections from a simple point-to-point to a multi-point to multi-point setup via LAN without distance limitations
- Offers multi-functionality in extender, splitter, matrix switch, video wall and daisy chain applications

• Collaboration with ATEN Control System

- Integrated solution – Compatible with ATEN Control System, allowing users to directly operate VE8950T via CLI Telnet or RS-232 protocol
- Effortless operation – One click to effectively operate VE Manager, TV, projector, source player, and related equipments via touch panel and keypad

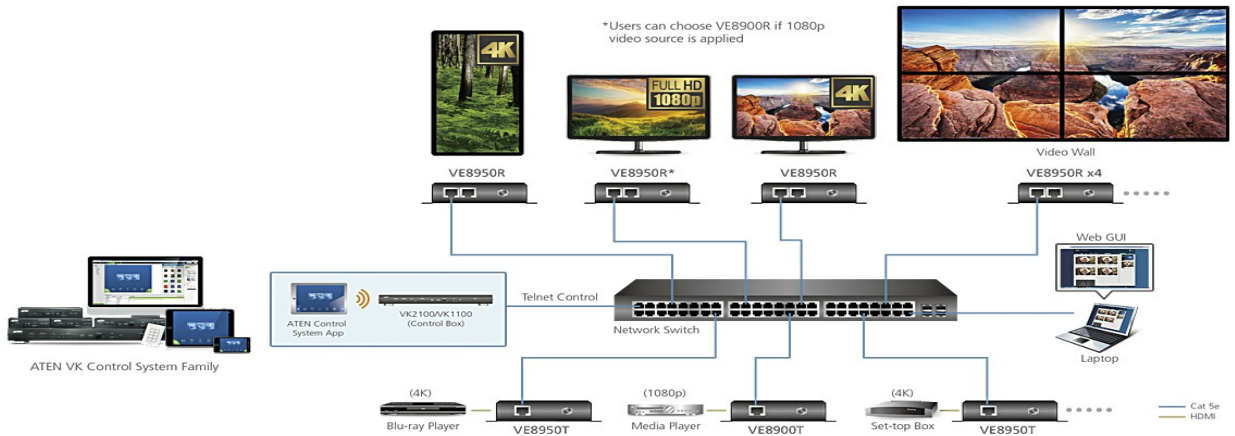

• Spontaneous Scheduling Management

- Offers an user-friendly scheduling management function for users to pre-plan the display schedule
- Provides robust and intuitive scheduling management options to help users to manage all events in the calendar as to as detailed as to setting events to minute intervals
- Integrates all VE89 units to arrange the profile by grouping individual receiver or video wall
- Multiple profiles can be arranged to play in any order over a selected period of time

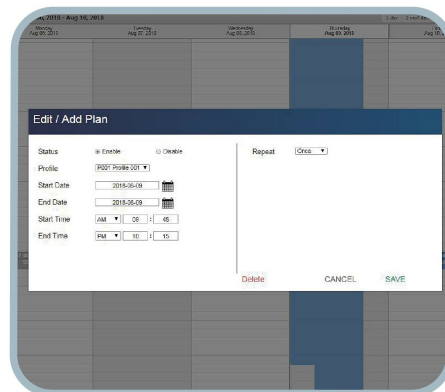
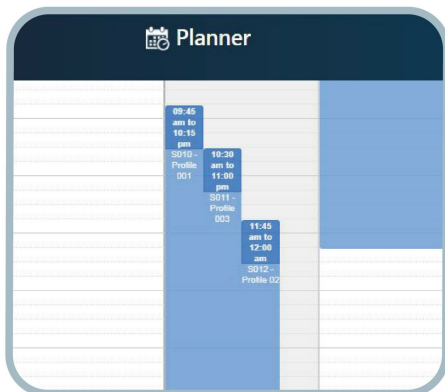

• No Complicated IP Setup

- Simple configuration that requires no extensive IT experience or extra learning
- Effortlessly switches among input sources via top panel pushbuttons



• **Web GUI-Based Management, No Additional Server PCs or Software Required**

- Simple Access – Without typing IP address on Chrome browser, users are allowed to directly link to VE Manager via one click on “Find My VE” Chrome based free tool

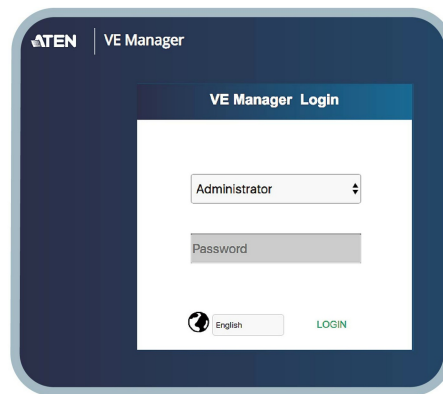
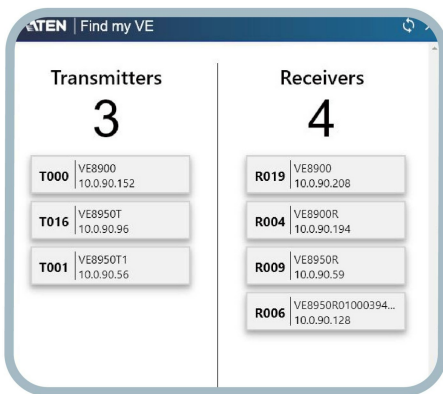

• **Go Further For Less with Daisy Chaining***

- Connects multiple displays through a single port to utilize every port of the network switch and maximize their value
 - Easily expandable – cabling and system deployment is easy with no huge network switches and fewer cables needed
 - Perfect for large-scale deployment covering hundreds of meters, such as hotel facilities, airports, university campuses, stations, shopping malls, and exhibition centers
- * Depending on your network architecture, we recommend daisy chaining up to 30 units. Please contact ATEN representatives for more details.

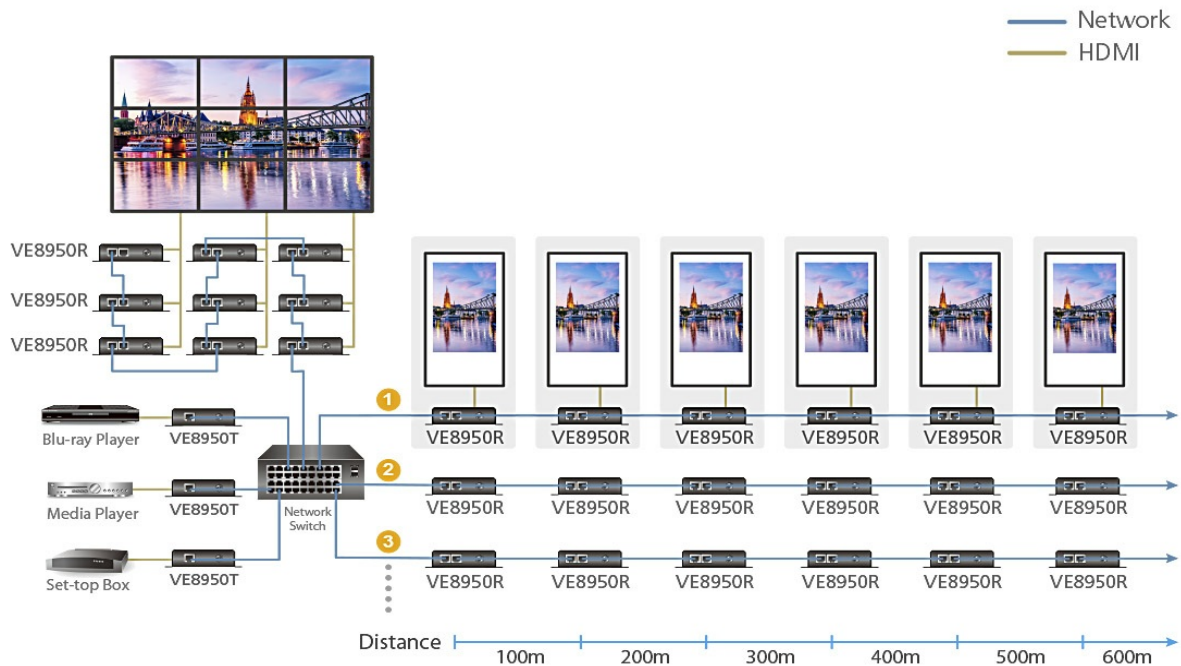

*Use daisy chains to configure a video wall or expand the AV system hundreds of meters

• Video Wall Support

- Supports up to 8 x 8 video wall (64 displays)*
- Supports horizontal or vertical (90° and 270° rotation) display orientation
- Easily switches layout profiles, preview and drag-and-drop video sources via the intuitive web GUI
- *Depends on your network architecture, please contact ATEN representatives for more details.

• Embedded / De-embedded Audio Support

- Separate audio signal can be embedded into the HDMI stream

• Multiple Control Channels

- Multiple control methods – the system can be managed via Ethernet or top-panel pushbuttons
 - USB Connectivity – USB port (USB 2.0) allows for connection of devices such as keyboard, mouse, flash drive, printer, and other USB peripherals*
 - Bi-directional IR Channel – IR transmission is processed one way at a time
 - RS-232 Channel – bi-directional RS-232 serial port allows for connection of peripherals such as touch screens and bar code scanners
- Note: *Each VE8950T transmitter can be controlled by a total of 4 USB touch screens installed to [VE8950R](#) receivers.

Please refer to the FAQ link below on how to select network switches and network switch information collected by ATEN Customer Service Division, where the collected information includes customer's feedback from their actual experience in using and installing the product(s).
<https://eservice.aten.com/eServiceCx/Common/FAQ/view.do?id=6276>

Specifications

Video Input	
Interfaces	1 x HDMI Type A Female (Black)
Impedance	100 Ω
Max. Distance	3 m
Video	
Max. Data Rate	Average: 150 ~ 500Mbps
Compliance	HDMI (4K) HDCP Compatible
Max. Resolutions / Distance	Up to 4K@100m (Cat 5e/6, point to point) *4K supported: 4096 x 2160 / 3840 x 2160 @ 60Hz (4:2:0); 4096 x 2160 / 3840 x 2160 @ 30Hz (4:4:4)
Audio	
Input	1 x HDMI Type A Female (Black) 1 x Mini Stereo Jack Female (Green)
Connectors	
Unit To Unit	1 x RJ-45 Female
Power	1 x DC Jack (Black) with locking
Control	
IR	1 x Mini Stereo Jack Female (Black)
RS-232	Connector: 1 x Terminal Block, 3 pole Baud Rate: 19200, Data Bits:8, Stop Bits:1, no parity and flow control
USB	1 x USB Type B Female (White)
Pushbuttons	
ID Number Selection	2 x Push buttons
Power Consumption	DC5V:3.08W:14BTU/h Note: ● The measurement in Watts indicates the typical power consumption of the device with no external loading. ● The measurement in BTU/h indicates the power consumption of the device when it is fully loaded.
Environmental	
Operating Temperature	0 - 40°C
Storage Temperature	-20 - 60°C
Humidity	0 - 80% RH, Non-Condensing
Physical Properties	
Housing	Metal
Weight	0.50 kg (1.1 lb)
Dimensions (L x W x H) with bracket	14.02 x 12.30 x 3.06 cm (5.52 x 4.84 x 1.2 in.)
Dimensions (L x W x H) without bracket	13.60 x 10.10 x 2.96 cm (5.35 x 3.98 x 1.17 in.)

Diagram

► Connection Diagram

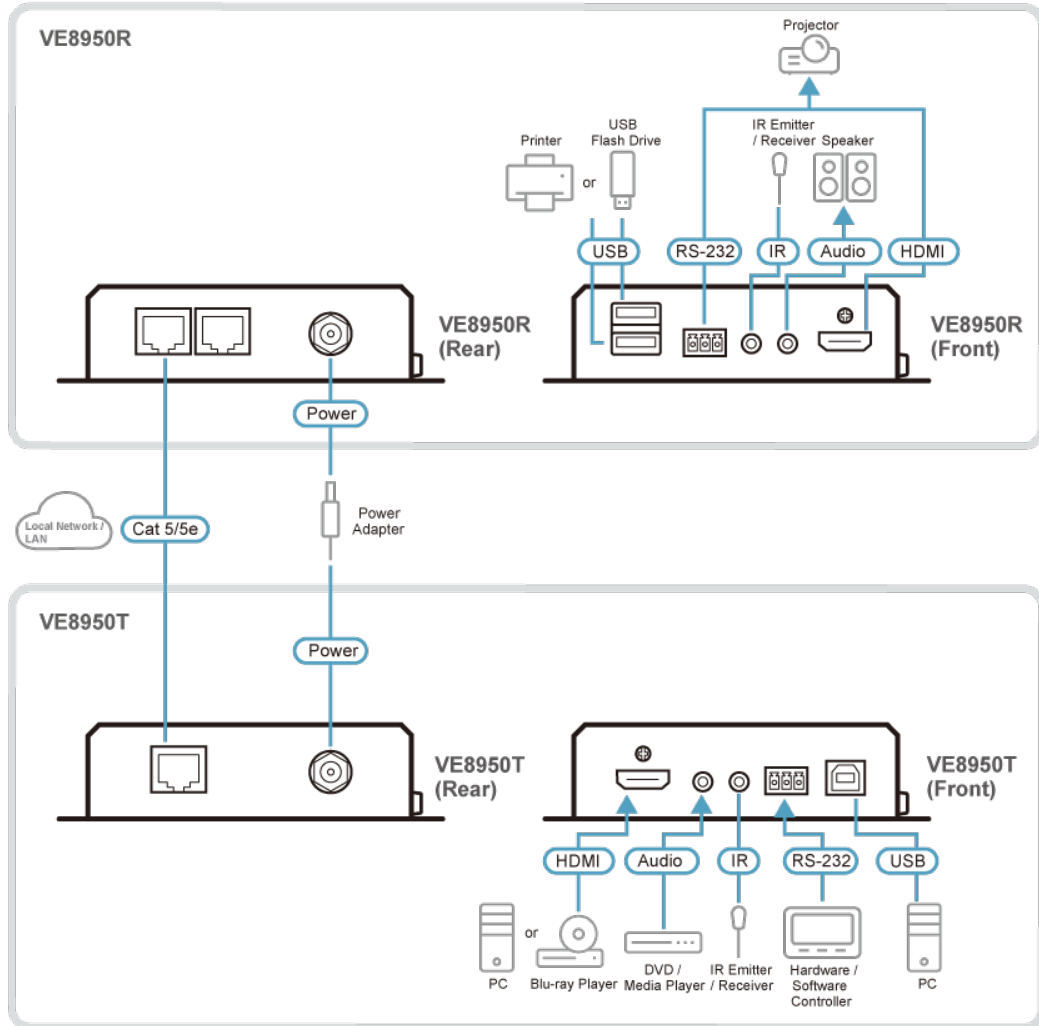

ATEN International Co., Ltd.

3F., No.125, Sec. 2, Datong Rd., Sijhih District., New Taipei City 221, Taiwan
 Phone: 886-2-8692-6789 Fax: 886-2-8692-6767
 www.aten.com E-mail: marketing@aten.com



© Copyright 2015 ATEN® International Co., Ltd.
 ATEN and the ATEN logo are trademarks of ATEN International Co., Ltd.
 All rights reserved. All other trademarks are the property of their respective owners.