

PE6208AV

8-Outlet eco PDU



PE6208AVX, one of the variants of the series, is discontinued.

Ideal for Pro-A/V applications, the ATEN NRGence™ PE6208AV eco PDUs are intelligent, 1U rack PDUs that contain 8 AC outlets available in an IEC socket configuration. The unique design with detachable front panel is convenient and mounts with different Pro-A/V equipment in 19" racks with different depths. In addition to remotely controlling individual outlets over the LAN, the front panel pushbuttons offer an extra option to control the outlets locally, allowing the flexibility to easily shutdown Pro-A/V equipment on the spot or from a remote location – for reduced power consumption. The outlets feature a sequential power-ON function that ensures Pro-A/V systems are powered on safely. Furthermore, compatibility with the ATEN Control System and Control4 libraries allow the PE6208AV to integrate with any Pro-A/V equipment for full control of all devices without complex programming.

The PE6208AV are optimal energy solutions for data centers as well. With the combination of ATEN eco PDUs and [eco DC](#) Energy Management software, a data center will be equipped with real-time monitoring, measurement, and analysis of energy consumption – with reports of power usage and PUE to meet the ISO 50001 requirements. These indices reflect the data center's energy usage and offer energy saving suggestions for optimizing energy use and reducing costs.

Features

- **Connections**
 - Detachable front panel fits 19" racks with different depths
 - Built-in 10/100 Mbit Ethernet Interface
 - Supports TCP/IP, UDP, HTTP, HTTPS, SSL, DHCP, SMTP, ARP, NTP, DNS, Auto Sense, Ping, SNMP V1, V2, and V3, Telnet
 - 2-level account/password security, IP/MAC filter, 128 bit SSL, RADIUS
 - Browser access via IE, Firefox, Chrome, Safari, and more
 - Easy integration with ATEN Control System and Control4 libraries
 - Supports RS-232 port and power outlet control (on/off) by outlet group

- **Metering**
 - 1% Metering Accuracy – supports bank-level power metering
 - Environment Monitoring – supports external temperature or temperature and humidity sensors for rack temperature and humidity monitoring

- **Outlet Switch Control**
 - Remote and local power outlet control (On/Off, Power Cycle) by individual outlets and outlet groups
 - Multiple Power Control Methods – Wake on LAN, System After AC Back, Kill the Power
 - Power-On Sequencing – users can set the power-on sequence and delay time for each outlet to allow equipment to be powered on in the correct order to enhance equipment safety
 - Proactive Overload Protection (POP) – automatically powers off the last outlet that caused the current overload to protect high-end pro-A/V equipment and servers

- **eco DC Energy Management Software***
 - Automatic discovery of all ATEN PDUs within the same intranet
 - Remote real-time power measurement and monitoring of PDUs
 - Real-time environment monitoring via sensors
 - Plotting and monitoring of all ATEN PDU devices
 - Exceed threshold alerts through real-time monitoring, SMTP, and System logs
 - Power analysis reports

* [eco DC](#) is designed to work with NRGence™ eco PDUs and is bundled with all PE Series models.

Specifications

Function	PE6208AVA	PE6208AVB	PE6208AVG	PE6208AVX
Electrical				
Nominal Input Voltage	100 – 120 VAC	100 – 240 VAC	100 – 240 VAC	100-240 VAC
Maximum Input Current	20A(Max), 16A(UL de-rated)	20A(Max)16A(UL de-rated)	16A(Max)	16A(Max)
Input Frequency	50-60 Hz	50-60 Hz	50-60 Hz	50-60 Hz
Input Connection	A/J:NEMA L5-20P A2/J2: NEMA 5-20P	NEMA 6-20P	IEC 60320 C20	Terminal(3P)
Input Power	2400VA(Max),1920VA(UL de-rated)	4600VA(Max),3680VA(UL de-rated)	3680 VA(Max)	4800VA(Max)
Outlet Type	Total : 8 x NEMA 5-20R	Total: 8 x IEC320 C13	Total: 8 x IEC320 C13	Total : 8 x Terminal(3P)
Nominal Output Voltage	100 –120 VAC	100 – 240 VAC	100 – 240 VAC	100-240 VAC
Maximum Output Current (Outlet)	NEMA 5-20R : 20A (Max) 16A (UL de-rated)	C13: 15A(Max) 12A(UL de-rated)	C13: 10A	16A (Max)
Maximum Output Current (Bank)	20A (Max) 16A (UL de-rated)	20A (Max) 16A (UL de-rated)	16A(Max)	16A (Max)
Maximum Output Current (Total)	20A (Max) 16A (UL de-rated)	20A (Max) 16A (UL de-rated)	16A(Max)	16A (Max)
Metering	Per Bank level Current, Voltage, VA , PF and KWh Monitoring	Per Bank level Current, Voltage, VA , PF and KWh Monitoring	Bank Level Current, Voltage, VA , PF and kWh Monitoring	Per Bank level Current, Voltage, VA , PF and KWh Monitoring
Outlet Switching	Yes	Yes	Yes	Yes
Environment Sensor Ports	2	2	2	2
Metering Accuracy	Voltage range: 100VAC ~ 250VAC +/-1% Power range: 100W ~ 5000W +/- 2% Current range: 0.1A~1A +/- 0.1A, 1A~20A +/-1%	Voltage range: 100VAC ~ 250VAC +/-1% Power range: 100W ~ 5000W +/- 2% Current range: 0.1A~1A +/- 0.1A, 1A~20A +/-1%	"Voltage range: 100VAC ~ 250VAC +/-1% Power range: 100W ~ 5000W +/- 2% Current range: 0.1A~1A +/- 0.1A, 1A~20A +/-1%"	Voltage range: 100VAC ~ 250VAC +/-1% Power range: 100W ~ 5000W +/- 2% Current range: 0.1A~1A +/- 0.1A, 1A~20A +/-1%
Communication				
10/100 Mbps	1 x RJ-45	1 x RJ-45	1 x RJ-45	1 x RJ-45
RS-232	1 x DB-9	1 x DB-9	1 x DB-9	1 x DB-9
Switches				
Power	Yes	Yes	Yes	Yes
Physical Properties				
Dimensions (L x W x H)	43.24 x 26.72 x 4.4 cm (17.02 x 10.52 x 1.73 in.)	43.24 x 26.72 x 4.4 cm (17.02 x 10.52 x 1.73 in.)	43.24 x 26.72 x 4.4 cm (17.02 x 10.52 x 1.73 in.)	43.24 x 26.72 x 4.4 cm (17.02 x 10.52 x 1.73 in.)
Weight	3.76 kg (8.29 lb)	3.76 kg (8.29 lb)	3.76 kg (8.29 lb)	3.76 kg (8.29 lb)
Power Cord Length	3 m	3 m	3 m	N.A.
Environmental				
Temperature (Operating / Storage)	0 – 50°C / -20 – 60°C	0 – 50°C / -20 – 60°C	0–40°C / -20–60°C	0 – 50°C / -20 – 60°C
Humidity (Operating & Storage)	0–80% RH, Non-Condensing	0–80% RH, Non-Condensing	0–80% RH, Non-Condensing	0–80% RH, Non-Condensing
Compliance				
EMC Verification	FCC, J55032	FCC Others by Request	CE-EMC, FCC, J55032 Others by Request	FCC,CE
Safety Verification	PSE	Others by Request	CE-LVD, PSE, Others by Request	CE,LVD

Note	For some of rack mount products, please note that the standard physical dimensions of WxDxH are expressed using a LxWxH format.
------	---

Diagram

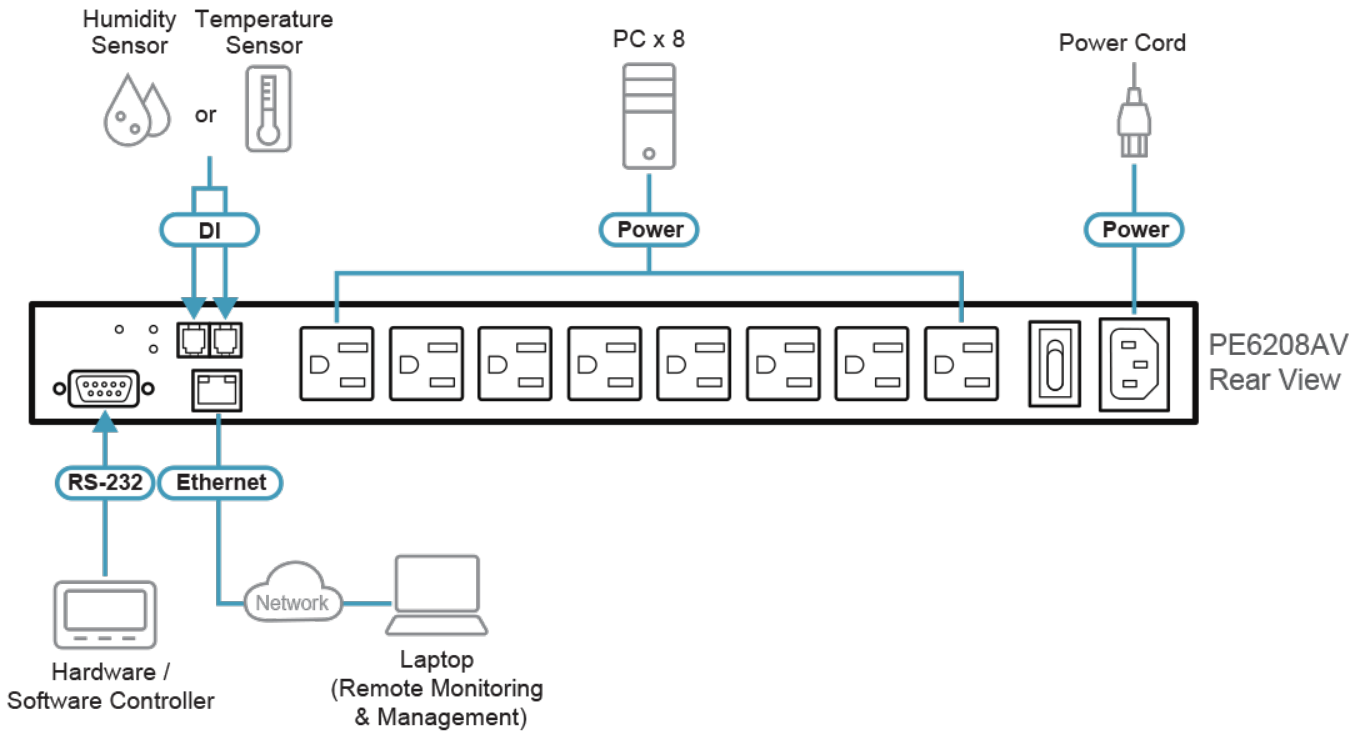

ATEN International Co., Ltd.

3F, No.125, Sec. 2, Datong Rd., Sijhih District., New Taipei City 221, Taiwan
 Phone: 886-2-8692-6789 Fax: 886-2-8692-6767
 www.aten.com E-mail: marketing@aten.com



© Copyright 2015 ATEN® International Co., Ltd.
 ATEN and the ATEN logo are trademarks of ATEN International Co., Ltd.
 All rights reserved. All other trademarks are the property of their respective owners.