

CL3800

Ultra Short Depth Dual Rail WideScreen LCD Console (USB, HDMI / DVI / VGA)



CL3800NX is discontinued

The CL3800 USB HDMI DVI VGA LCD Console is a short depth dual rail LCD KVM console featuring an 18.5" LED-backlit widescreen LCD monitor with an integrated keyboard and touchpad. The short-depth design fits all 19" equipment cabinets, and is especially suitable for shallow racks. In addition to saving valuable space on the rack, the CL3800 also provides a space-saving solution for special environments, such as outside broadcast vans (OB vans) and compact control rooms.

The CL3800 supports three types of video input – HDMI, DVI, and VGA – and provides the ultimate in installation flexibility by allowing users to connect the console and the computer via any of the three types of video source. The CL3800NW's full HD widescreen LCD monitor ensures excellent video quality and provides ample viewing area.

Furthermore, the dual rail design enables the LCD monitor, keyboard and touchpad to operate independently of each other. To maximize space utilization, the keyboard and touchpad modules can slide back to "hideaway" when not in use, while the thin profile LCD monitor rotates back, flush against the rack, to allow the convenient monitoring of computer activity.

For added convenience, users can choose to manage the computer from an external console. The CL3800 features a port for an external USB mouse on the unit's front panel, while ports for the second KVM console (USB keyboard/mouse and HDMI, DVI, or VGA monitor) are provided on the rear panel. The CL3800 also includes two mini stereo ports for connecting audio speakers.

With a rich feature set, the CL3800 is designed to exceed the requirements for space utility optimization, superior video quality, adaptive deployment, and operational versatility, and is ideal for applications such as mobile live streaming in the broadcasting sector or control rooms with limited space in any industry.

Note: Optional rack mount kits are available. For more information, refer to Compatible Accessories below.







CL3800NW: 18.5" LCD screen with Full HD resolution of 1920 x 1080 @ 60Hz
CL3800NX: 18.5" LCD screen with resolution of 1366 x 768 @ 60Hz (Discontinued)

LCD KVM Consoles and Switches

Space-optimizing KVM solutions for server rooms

LCD KVM Consoles and Switches are space-optimizing KVM solutions for server rooms and are specifically designed for short rack applications, including limited-space telecoms, broadcasting, and surveillance server rooms.

The benefits of using LCD KVM consoles and switches in your server room or other rack applications are varied, and include:

	All-in-One Design	The LCD panel, keyboard, and touchpad are integrated into a 1U rack-mountable sliding housing
	Control Attached Servers Directly	Easily and conveniently control servers through LCD KVMs
	Multiplatform Support	LCD KVMs support PC*, Mac and Sun
	Supports Popular Video Interfaces	LCD KVM switches can connect to DP**, HDMI, DVI, and VGA
	LED Illumination	Exclusive LED illumination lights up the keyboard and touchpad for better visibility in low-light conditions
	Easy Installation	Optional Single-Person Easy Installation Rack Mount Kits are also available
	Multi-View Display	Controls up to four video sources on one screen with display modes including Quad View, Picture in Picture (PiP), Picture by Picture (PbP), and Picture on Picture (PoP)

Front View	
LCD KVM Console	LCD KVM Switch
Rear View	
Connects to a KVM Switch or 1 server directly	Connects to 4/8/16 servers directly

Selection Tree

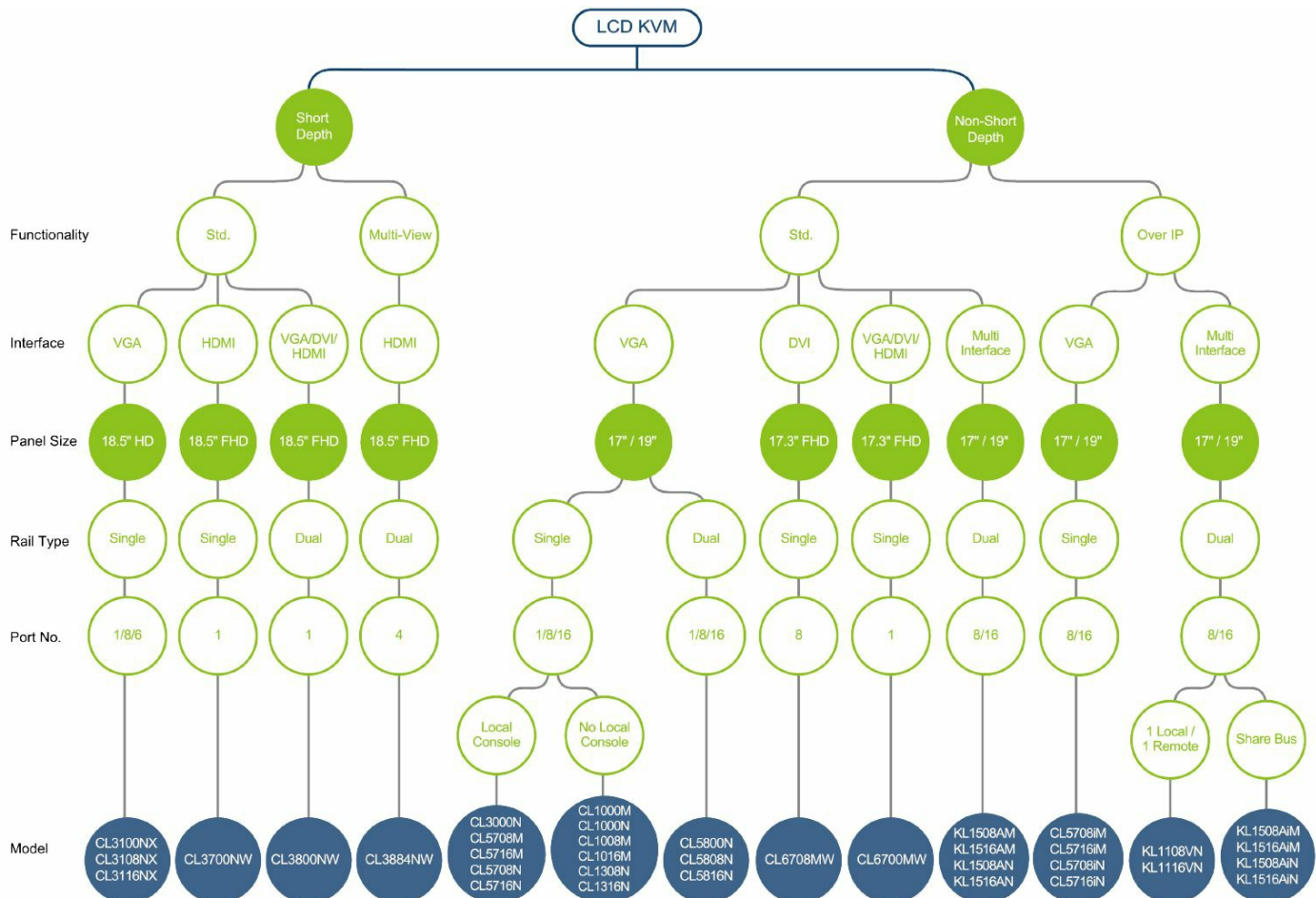

LCD KVM Switch/Console – Model Selection Guide

Multi-Interfaces			KL1508AM* KL1508AN*	KL1516AM* KL1516AN*	Panel resolution <ul style="list-style-type: none"> ● 1280x1024 ● 1366x768 ● 1920x1080 LCD Panel -M: 17" -MW: 17.3" wide-screen -N: 19" -NW: 18.5" wide-screen Features *Dual Rail #Ultra Short Depth
HDMI/DVI/VGA	<ul style="list-style-type: none"> ● CL3800NW*# CL3800NX*# ● CL6700MW CL6700N 				
HDMI	<ul style="list-style-type: none"> ● CL3700NW# 	<ul style="list-style-type: none"> ● CL3884NW* 			
DVI			<ul style="list-style-type: none"> ● CL6708MW 		
VGA	CL1000M CL1000N CL3000N <ul style="list-style-type: none"> ● CL3100NX# CL5800N*		<ul style="list-style-type: none"> ● CL3108NX CL1308N CL5808N* CL5708M ● CL5708MW CL5708N 	<ul style="list-style-type: none"> ● CL3116NX CL1316N CL5816N* CL5716M ● CL5716MW CL5716N 	
	1-Port	4-Port	8-Port	16-Port	

How to install Ultra Short Depth LCD consoles with ATEN 2-in-1U mounting kit?



Features

• Space Utility Optimization

- Exclusive LED illumination light – designed by ATEN to illuminate the keyboard and touchpad to allow visibility in low-light conditions
- Integrated LCD KVM console with an 18.5" LED-backlit widescreen LCD monitor in a dual rail housing with top and bottom clearance for smooth operation in a 1U high system rack
- Short-depth design allows you to work with your rack-mounting equipment in narrow spaces
- Dual rail design allows LCD monitor and keyboard/touchpad modules to operate independently
- Console lock – enables the console drawer to remain securely locked away in position when not in use
- Optional 2-in-1U Mounting Kit (2K-0001/2K-0002/2K-0007) – fitting the CL3800 and a rack KVM switch/KVM over IP switch in 1U of space on a rack for space-saving, easy and flexible operation ¹

• Remarkable Audio/Video Experience

- Support three types of video inputs – HDMI, DVI, and VGA ¹
- The 18.5" LCD screen offers resolutions of up to 1920 x 1080 (Full HD) @ 60Hz for CL3800NW and resolutions of up to 1366 x 768 @ 60Hz for CL3800NX
- External console supports input video resolutions up to 1920 x 1200 @ 60Hz
- Audio support for connecting speakers

• Installation Flexibility

- Standard rack mount kit included
- Optional rack mount kits available including easy installation options²
- No software required
- Firmware upgradable
- Supports hot-plugging

• Reliability and Operational Versatility

- Supports an external console with USB / HDMI / DVI / VGA connectors ¹
- Additional hot-pluggable USB mouse port on front panel (also functions as a USB peripheral port)
- Console selection via hotkey
- Standard 105-key keyboard

Note:

1. Only one video signal (HDMI, DVI-D, or VGA) can be displayed at a time.
2. Contact your ATEN dealer for product information.

[More information about "Easy Rack Mounting"...](#)



Specifications

Function	CL3800NW	CL3800NX
Computer Connections		
Direct	1	1
Console Selection	Hotkey	Hotkey
Connectors		
KVM Ports	1 x HDMI Female 1 x DVI-D Female (White) 1 x HDB-15 Male (Blue) 1 x USB Type B Female 1 x 3.5mm Audio Jack Female (Green)	1 x HDMI Female 1 x DVI-D Female (White) 1 x HDB-15 Male (Blue) 1 x USB Type B Female 1 x 3.5mm Audio Jack Female (Green)
Firmware Upgrade	1 x 3.5mm Audio Jack Female (Black)	1 x 3.5mm Audio Jack Female (Black)
Power	1 x IEC 60320/C14	1 x IEC 60320/C14
External Console Ports	1 x HDMI Female 1 x DVI-D Female (White) 1 x HDB-15 Female (Blue) 2 x USB Type A Female 1 x 3.5mm Audio Jack Female (Green)	1 x HDMI Female 1 x DVI-D Female (White) 1 x HDB-15 Female (Blue) 2 x USB Type A Female 1 x 3.5mm Audio Jack Female (Green)
External Mouse / Peripheral	1 x USB Type A Female (Front)	1 x USB Type A Female (Front)
Switches		

Reset	1 x Semi-recessed Pushbutton	1 x Semi-recessed Pushbutton
Firmware Upgrade	1 x Slide Switch	1 x Slide Switch
Power	1 x Rocker Switch	1 x Rocker Switch
LCD Control	4 x Pushbutton	4 x Pushbutton
LCD Power	1 x LED Pushbutton	1 x LED Pushbutton
LEDs		
Power	1 x KVM Console (Dark Green) 1 x LCD (Orange)	1 x KVM Console (Dark Green) 1 x LCD (Orange)
Lock	1 x Num Lock (Green) 1 x Caps Lock (Green) 1 x Scroll Lock (Green)	1 x Num Lock (Green) 1 x Caps Lock (Green) 1 x Scroll Lock (Green)
LED Illumination Light	1 x LED Illumination Light	1 x LED Illumination Light
Panel Spec		
LCD Module	18.5" TFT-LCD	18.5" TFT-LCD
Resolution	1920 x 1080 @ 60 Hz	1366 x 768 @ 60 Hz
Response time	20 ms	5 ms
Viewing Angle	178° (H), 178° (V)	170° (H), 160° (V)
Pixel Pitch	0.213 mm x 0.213 mm	0.3 mm x 0.3 mm
Support Color	16.77M colors	16.77M colors
Contrast Ratio	1000 : 1	1000 : 1
Luminance	350 cd/m ²	250 cd/m ²
Video		
Input Video Resolution	up to 1920 x 1200 @ 60Hz; 1920 x 1080 @ 60 Hz, DDC2B	up to 1920 x 1200 @ 60Hz; 1366 x 768 @ 60 Hz, DDC2B
Emulation		
Keyboard / Mouse	USB	USB
Maximum Input Power Rating	100–240V AC; 50–60Hz; 1A	100–240V AC; 50–60Hz; 1A
Power Consumption	AC110V:26.6W:140BTU/h AC220V:26.8W:141BTU/h Note: ● The measurement in Watts indicates the typical power consumption of the device with no external loading. ● The measurement in BTU/h indicates the power consumption of the device when it is fully loaded.	AC110:18.3W:101BTU/h AC220:17.8W:98BTU/h Note: ● The measurement in Watts indicates the typical power consumption of the device with no external loading. ● The measurement in BTU/h indicates the power consumption of the device when it is fully loaded.
Environmental		
Operating Temperature	0-40°C	0-40°C
Storage Temperature	-20-60°C	-20-60°C
Humidity	0 - 80% RH, Non-condensing	0 - 80% RH, Non-condensing
Physical Properties		
Housing	Metal + Plastic	Metal + Plastic
Rail Type	Dual Rail	Dual Rail
Weight	9.61 kg (21.17 lb)	9.79 kg (21.56 lb)
Dimensions (L x W x H)	48.06 x 51.42 x 4.28 cm (18.92 x 20.24 x 1.69 in.)	48.06 x 51.42 x 4.28 cm (18.92 x 20.24 x 1.69 in.)
Body Dimensions(L x W x H)	44.92 X 46.74 X 4.28 cm (17.69 x 18.40 x 1.69 in.)	44.92 X 46.74 X 4.28 cm (17.69 x 18.40 x 1.69 in.)
Note	Body Dimensions exclude I/O ports, handles, and mounting brackets.	Body Dimensions exclude I/O ports, handles, and mounting brackets.
Note	For some of rack mount products, please note that the standard physical dimensions of WxDxH are expressed using a LxWxH format.	

Diagram

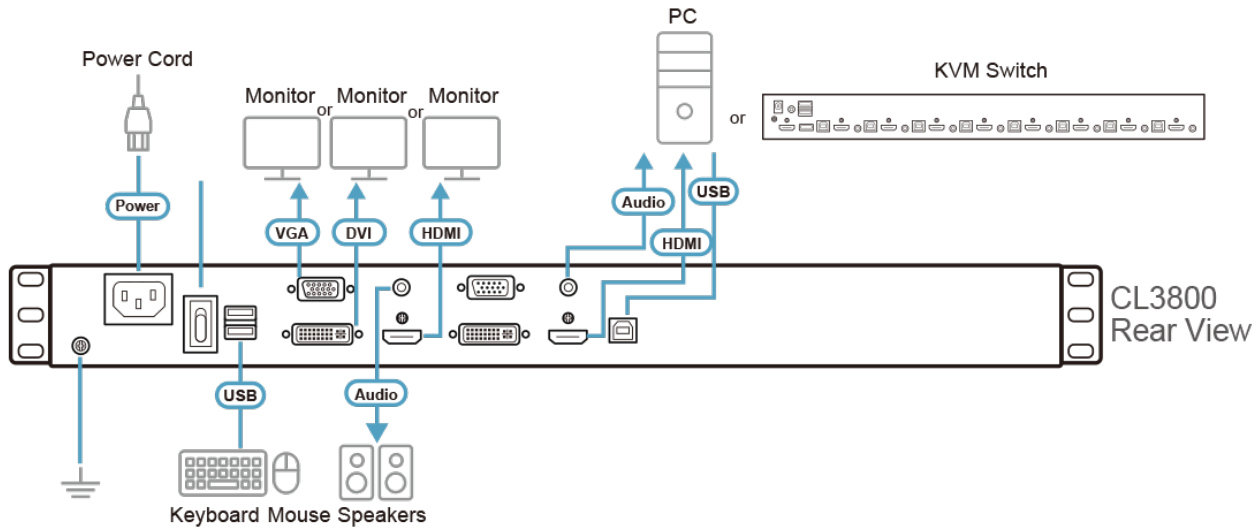

ATEN International Co., Ltd.

3F, No.125, Sec. 2, Datong Rd., Sijhih District., New Taipei City 221, Taiwan
 Phone: 886-2-8692-6789 Fax: 886-2-8692-6767
 www.aten.com E-mail: marketing@aten.com



© Copyright 2015 ATEN® International Co., Ltd.
 ATEN and the ATEN logo are trademarks of ATEN International Co., Ltd.
 All rights reserved. All other trademarks are the property of their
 respective owners.