

CL3100

Ultra Short Depth Single Rail WideScreen LCD Console (USB,VGA)



The CL3100 USB VGA LCD Console is a short depth single rail LCD KVM console featuring an 18.5" LED-backlit widescreen LCD monitor with an integrated keyboard and touchpad. The short-depth design fits all 19" equipment cabinets, and is especially suitable for shallow racks. The CL3100 provides an ideal space-saving solution for special environments such as outside broadcast vans (OB vans) and compact control rooms.

The CL3100 is a dedicated front end sliding console for compatible VGA KVM switches. For added convenience, users can choose to manage the computer from an external console. The CL3100 features a port for an external USB mouse on the unit's front panel, while ports for the second KVM console (USB keyboard/mouse and VGA monitor) are provided on the rear panel. The CL3100 also includes two mini stereo ports for connecting audio speakers.

With a rich feature set, the CL3100 is designed to exceed the requirements for space utility optimization, adaptive deployment, and operational versatility, and is ideal for applications such as mobile live streaming in the broadcasting sector or control rooms with limited space in any industry.







Note: Optional rack mount kits are available. For more information, refer to Compatible Accessories below.

LCD KVM Consoles and Switches

Space-optimizing KVM solutions for server rooms

LCD KVM Consoles and Switches are space-optimizing KVM solutions for server rooms and are specifically designed for short rack applications, including limited-space telecoms, broadcasting, and surveillance server rooms.

The benefits of using LCD KVM consoles and switches in your server room or other rack applications are varied, and include:

	All-in-One Design	The LCD panel, keyboard, and touchpad are integrated into a 1U rack-mountable sliding housing
	Control Attached Servers Directly	Easily and conveniently control servers through LCD KVMs
	Multiplatform Support	LCD KVMs support PC*, Mac and Sun
	Supports Popular Video Interfaces	LCD KVM switches can connect to DP**, HDMI, DVI, and VGA
	LED Illumination	Exclusive LED illumination lights up the keyboard and touchpad for better visibility in low-light conditions
	Easy Installation	Optional Single-Person Easy Installation Rack Mount Kits are also available
	Multi-View Display	Controls up to four video sources on one screen with display modes including Quad View, Picture in Picture (PiP), Picture by Picture (PbP), and Picture on Picture (PoP)

Front View	
LCD KVM Console	LCD KVM Switch
Rear View	
Connects to a KVM Switch or 1 server directly	Connects to 4/8/16 servers directly

Selection Tree

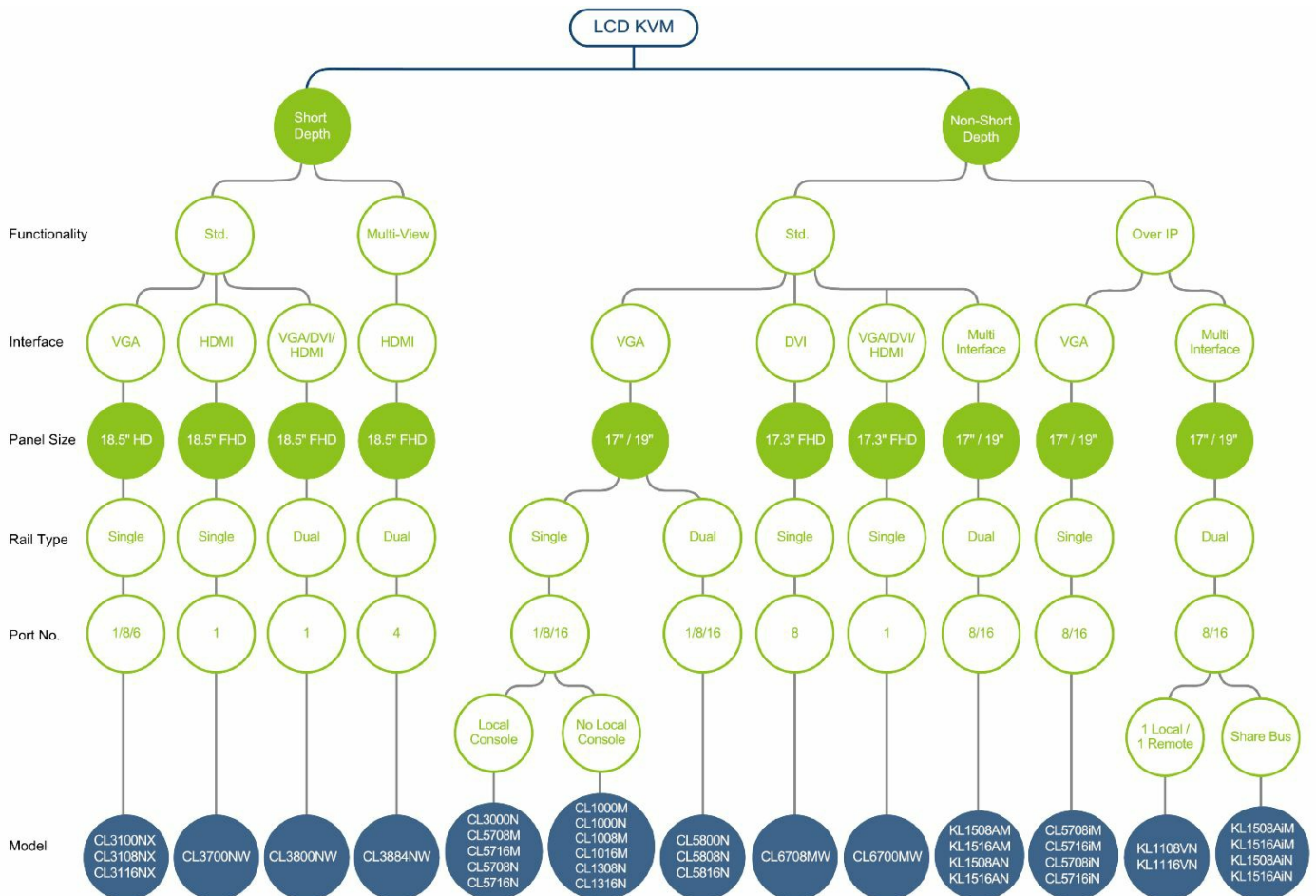

LCD KVM Switch/Console – Model Selection Guide

Multi-Interfaces			KL1508AM* KL1508AN*	KL1516AM* KL1516AN*	Panel resolution
HDMI/DVI/VGA	● CL3800NW*# CL3800NX*# ● CL6700MW CL6700N				● 1280x1024 ● 1366x768 ● 1920x1080
HDMI	● CL3700NW#	● CL3884NW*			LCD Panel
DVI			● CL6708MW		-M: 17" -MW: 17.3" wide-screen -N: 19"
VGA	CL1000M CL1000N CL3000N ● CL3100NX# CL5800N*		● CL3108NX CL1308N CL5808N* CL5708M ● CL5708MW CL5708N	● CL3116NX CL1316N CL5816N* CL5716M ● CL5716MW CL5716N	Features *Dual Rail #Ultra Short Depth
	1-Port	4-Port	8-Port	16-Port	

How to install Ultra Short Depth LCD consoles with ATEN 2-in-1U mounting kit?

Features

• **Space Utility Optimization**

- Exclusive LED illumination light – designed by ATEN to illuminate the keyboard and touchpad to allow visibility in low-light conditions
- Integrated LCD KVM console with an 18.5" LED-backlit widescreen LCD monitor in a single rail housing with top and bottom clearance for smooth operation in a 1U high system rack
- Short-depth design allows you to work with your rack-mounting equipment in narrow spaces
- Console lock – enables the console drawer to remain securely locked away in position when not in use
- Optional 2-in-1U Mounting Kit ([2K-0001/2K-0002/2K-0007](#)) – fitting the CL3100 and a rack KVM switch/KVM over IP switch in 1U of space on a rack for space-saving, easy and flexible operation*

• **Reliability and Operational Versatility**

- Supports VGA video input; supports an external console with USB / VGA connectors
- 18.5" LCD screen with resolution of 1366 x 768 @ 60Hz
- External console supports input video resolutions up to 1920 x 1200 @ 60Hz
- Audio support for connecting speakers
- Additional hot-pluggable USB mouse port on front panel (also functions as a USB peripheral port)
- Console selection via hotkey
- Standard 105-key keyboard

• **Installation Flexibility**

- Standard rack mount kit included
- Optional rack mount kits available including easy installation options*
- No software required
- Firmware upgradable
- Supports hot-plugging

[More information about "Easy Rack Mounting"...](#)

Specifications

Function	CL3100NX
Computer Connections	
Direct	1
Console Selection	Hotkey
Connectors	
KVM Ports	1 x SPHD Female (Yellow) 1 x 3.5mm Audio Jack Female (Green)
Firmware Upgrade	1 x 3.5mm Audio Jack Female (Black)
Power	1 x IEC 60320/C14
External Console Ports	1 x HDB-15 Female (Blue) 2 x USB Type A Female 1 x 3.5mm Audio Jack Female (Green)
External Mouse / Peripheral	1 x USB Type A Female (Front)
Switches	
Reset	1 x Semi-recessed Pushbutton
Firmware Upgrade	1 x Slide Switch
Power	1 x Rocker Switch
LCD Control	4 x Pushbutton
LCD Power	1 x LED Pushbutton
LEDs	
Power	1 x KVM Console (Dark Green) 1 x LCD (Orange)
Lock	1 x Num Lock (Green) 1 x Caps Lock (Green) 1 x Scroll Lock (Green)
LED Illumination Light	1 x LED Illumination Light
Panel Spec	
LCD Module	18.5" TFT-LCD
Resolution	1366 x 768 @ 60Hz
Response time	5 ms
Viewing Angle	170° (H), 160° (V)
Pixel Pitch	0.3 mm x 0.3 mm
Support Color	16.77M colors
Contrast Ratio	1000 : 1
Luminance	450 cd/m ²
Video	
Input Video Resolution	up to 1920 x 1200 @ 60Hz; 1366 x 768 @ 60 Hz, DDC2B
Emulation	
Keyboard / Mouse	USB
Maximum Input Power Rating	100–240 V AC, 50/60 Hz, 1 A
Power Consumption	AC110:13.8W:80BTU/h AC220:14.1W:81BTU/h Note: ● The measurement in Watts indicates the typical power consumption of the device with no external loading. ● The measurement in BTU/h indicates the power consumption of the device when it is fully loaded.

Environmental	
Operating Temperature	0–40°C
Storage Temperature	-20–60°C
Humidity	0–80% RH, Non-condensing
Physical Properties	
Housing	Metal + Plastic
Rail Type	Single Rail
Weight	9.07 kg (19.98 lb)
Dimensions (L x W x H)	48.06 x 47.70 x 4.28 cm (18.92 x 18.78 x 1.69 in.)
Body Dimensions(L x W x H)	44.92 x 43.00 x 4.28 cm
Note	Body Dimensions exclude I/O ports, handles, and mounting brackets.
Note	For some of rack mount products, please note that the standard physical dimensions of WxDxH are expressed using a LxWxH format.

Diagram

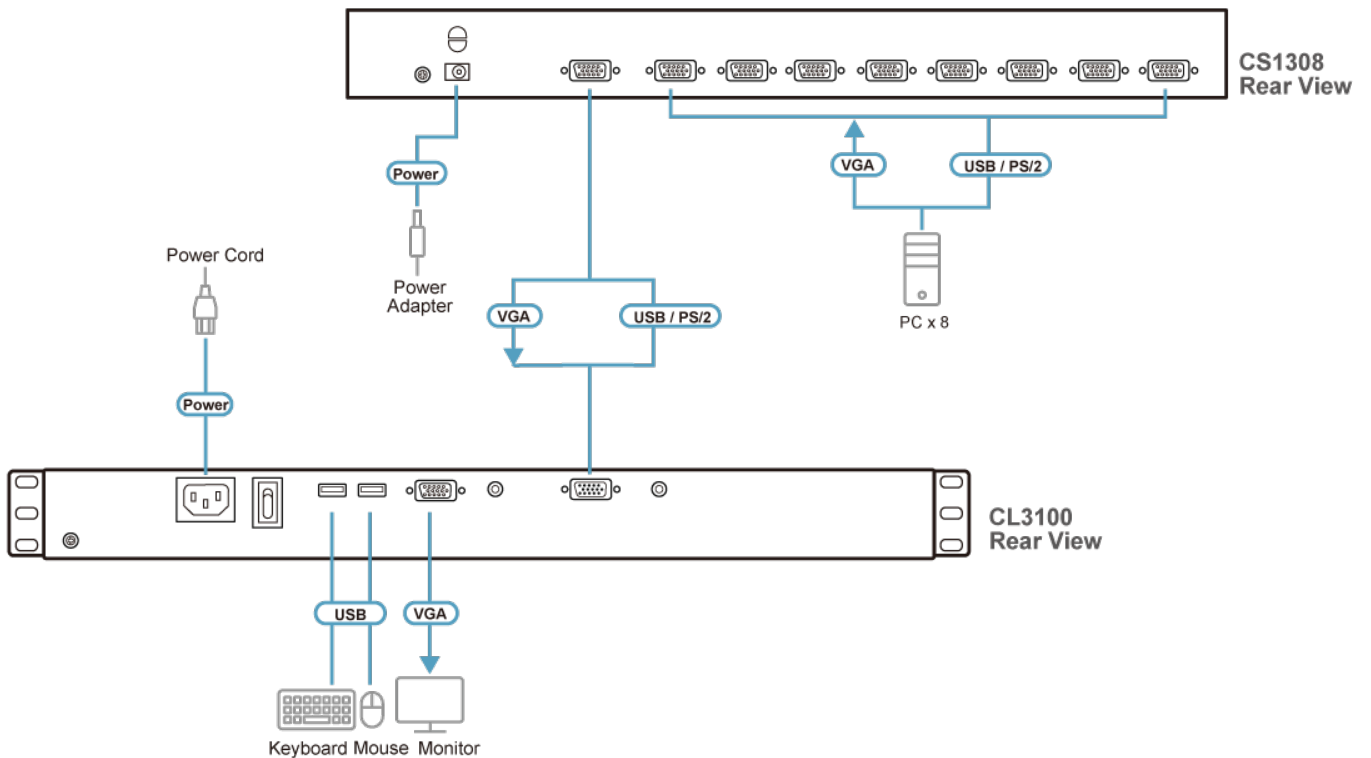



Simply Better Connections

ATEN International Co., Ltd.

3F., No.125, Sec. 2, Datong Rd., Sijhih District., New Taipei City 221, Taiwan
Phone: 886-2-8692-6789 Fax: 886-2-8692-6767
www.aten.com E-mail: marketing@aten.com



© Copyright 2015 ATEN® International Co., Ltd.
ATEN and the ATEN logo are trademarks of ATEN International Co., Ltd.
All rights reserved. All other trademarks are the property of their
respective owners.